



Thinking in solutions

Arbor and Adapter Systems

Tooling systems and application consulting
for the cutting of complex 2.5 and 3D geometries





Arbor system catalog

Dear customer,

This catalog provides up-to-date and detailed documentation for Pokolm Arbor and Adapter Systems.

To make your search even easier, this catalog is structured fully based on the machine-side connection.

Our arbor and adapter system product catalog has been expanded to meet current industry standards, with even more important and useful information.

We are sure that you will be able to find the products and information you need quickly in the new catalog structure. If you have any questions, suggestions or specific product requirements then do not hesitate to contact us!

We are happy to be of service and look forward to hearing from you!

Your Pokolm team

Food technology



Medical technology



Tool/mold construction



Turbine construction



 **pokolm**

Energy technology



Airplane construction



Mechanical engineering



Individual designs for any application

From intricate medical technology to high-powered racing applications – our services are used in a wide range of different industries. The demands placed on our products are as diverse as they are challenging. But they all have one thing in common: Every application demands the highest level of precision, quality, and expertise. It does not matter whether we are producing huge components for aviation or a highly specialized tool for the woodworking industry.

With such a wide variety of products, direct contact with our customers is essential. This is the only way we can understand precisely what specific challenges are at play. Our highly trained technical sales representatives will assist you directly on site, and address individual requirements flexibly with custom solutions. This kind of service is what makes us experts in our industry.

Process optimization, guaranteed

Standing still is a step backwards. That is why we are continuously developing our product portfolio. This is the only way we can remain a technological leader in the field. It is also the only way you can benefit from our innovations and patents, to secure your competitive advantage for the long term.



DUOPLUG®, SPINWORX® and other patents

THINKING IN SOLUTIONS

Purchase- and Info-Hotline

Pokolm Frästechnik GmbH & Co. KG



+49 5247 9361-0



+49 5247 9361-99



info@pokolm.de



7:30 AM – 6:00 PM (weekdays)



Order before 5:00 pm
for same-day delivery!



+49 5247 9361-0

Visit our website



www.pokolm.de/en

Structure: 1. Machine | 2. Tool

Being better means not just staying ahead of the competition but also scrutinizing our own products and services looking for ways to improve and become more efficient. Pokolm is well-known for this practice. This is also one of the reasons why successful practitioners choose Pokolm premium tools. This added value gives Pokolm customers a decisive edge over the competition, and is created by merging excellent products with outstanding technical service advice and tailoring both entirely to the needs of the customer. The structure of the product range and the corresponding documentation must also be 100% customer-oriented in accordance with Pokolm's standards.

Machine connection, e.g.

SK, HSK or BT in all common taper forms

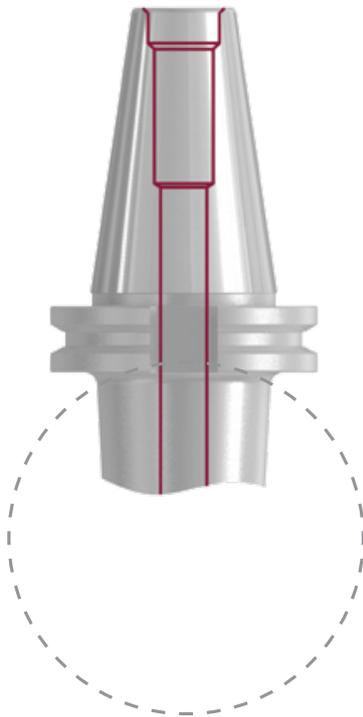

Tool connection, e.g.



Drill chucks



Collet chucks



Morse tapers



Shrink fit arbors

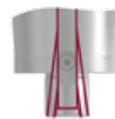

Arbors for shell type milling cutters



CoolCap®

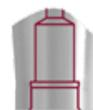

Arbors for thread connection



Shrink SB

The structure of the Pokolm arbor and adapter catalog is focused on our customers' needs. This is because it is structured around the machine-side connection. Simply choose the connection type and connection dimension in the structure for the type of machine in use and all of the corresponding tool connections will be listed under it. The arbors within this group are then categorized according to the connection type and size.

THINKING IN SOLUTIONS



Overview of arbor and adapter systems

Table of contents

	Page
Adapters, extensions, collets, drill chucks	23
Hollow shank tapers HSK.....	49
Steep tapers SK / BT	95
Flat contact surfaces	151
Accessories	159
Order / request forms	167
Spindle systems / shrink technology	173
Assembly instructions.....	177
Index	184

Balance

Balancing grade of Pokolm arbors

Arbor type	ISO/BT			HSK					
View									
Size	30	40	50	25	32	40	50	63	100
Form	-	-	-	all	all	all	all	all	all
Grade level	2.5	6.3	6.3	2.5	2.5	2.5	2.5	2.5	6.3
RPM	30,000	18,000	12,000	40,000	30,000	30,000	30,000	25,000	12,000

We would be glad to implement balancing grades and special requests deviating from this table – please ask our sales personnel.

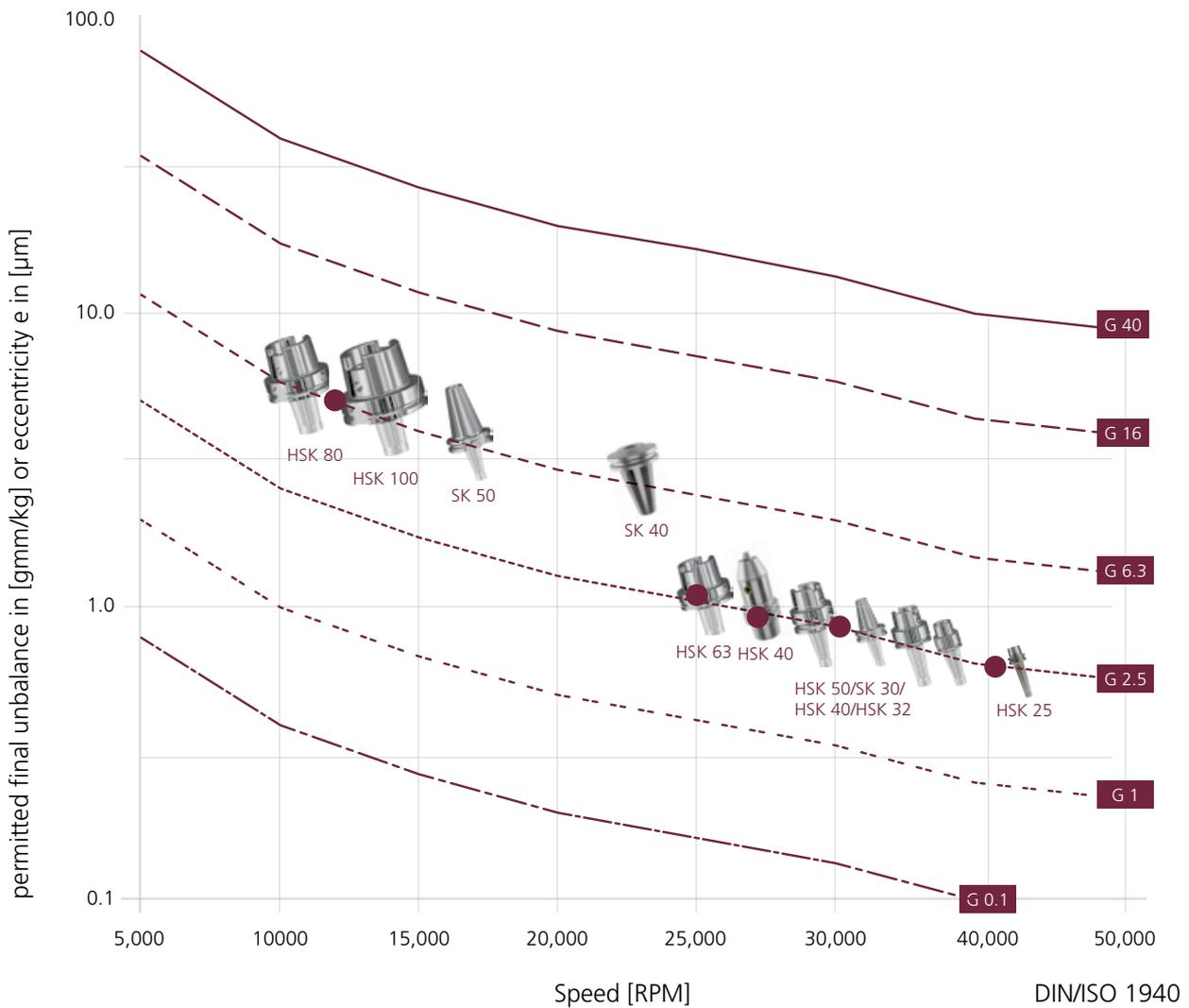

Calculations and definitions

Balancing grade classes and typical applications

G 0.4	e.g. ultrafine grinding machines
G 1	e.g. small motors, grinding machine drives
G 2.5	e.g. tools, small tool arbors, electric motors, turbines
G 6.3	e.g. tools, tool arbors, tooling machine parts
G 16	e.g. large tool arbors, cardan shafts, drive shafts
G 40	e.g. drive shafts, car wheels, crankshaft drives

List of formulas:

Calculation of final unbalance in [gmm/kg]	Calculation of angular frequency in [1/s]	Calculation of balancing grade in [mm/s]	Calculation of equalizing weight
$e = \frac{U}{m}$	$\omega = \frac{2 \cdot \pi \cdot n}{60}$	$G = e \cdot \omega = \frac{U \cdot \pi \cdot n}{m \cdot 30}$	$m_r = \frac{e \cdot m}{r}$

Terms and dimensions:

G = balancing grade in [mm/s]	U = unbalance ($m \cdot e$) in [gmm]
e = final unbalance in [gmm] or center gravity shift in [μm]	m = rotor weight in [g]
ω = angular frequency ($2 \cdot \pi \cdot f$) in [1/s]	F = centrifugal force ($U \cdot \omega$) in [N]
f = frequency ($n/60$) in [1/s]	r = radius of unbalance in [mm]
n = speed in [U/min]	m_r = final unbalance [g]

Balance error and balancing

Definition of balance error

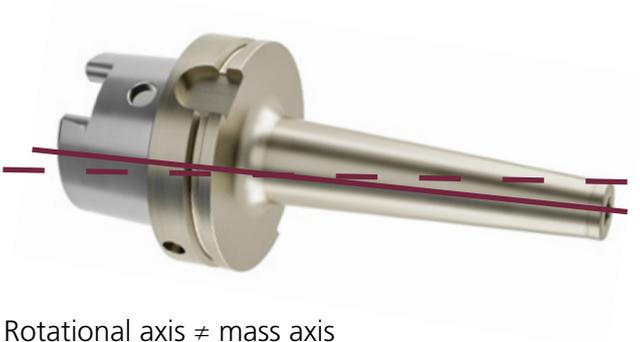

Rotational axis \neq mass axis



Rotational axis = mass axis

If the mass axis of a rotating part is not the same as its rotational axis, this is considered a balance error.

What can cause a balance error?

- Changeover positioning corner in SK and HSK
- Driving slots for SK and BT
- Driving slots for HSK Form A, C, CE
- Weldon surfaces on shank
- Straining screws for e.g. Weldon
- Uneven pitch on milling bodies
- Collets and collet nuts
- Production tolerances

When balancing a tool arbor, a balance error is compensated for either by adding compensating bores or adding material (see image: balancing by adding compensating bores).



Unbalanced arbor



Balanced arbor with compensating bore

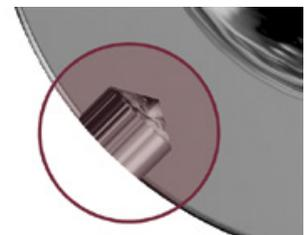

Balancing by adding compensating bores
Example calculations and detailed diagram on the next page.

Example calculation

HSK shrink fit arbor, 50 08 A63 S | weight: 760g
 Taper radius: 31.5 mm | balancing grade G 2.5 at 25,000 RPM

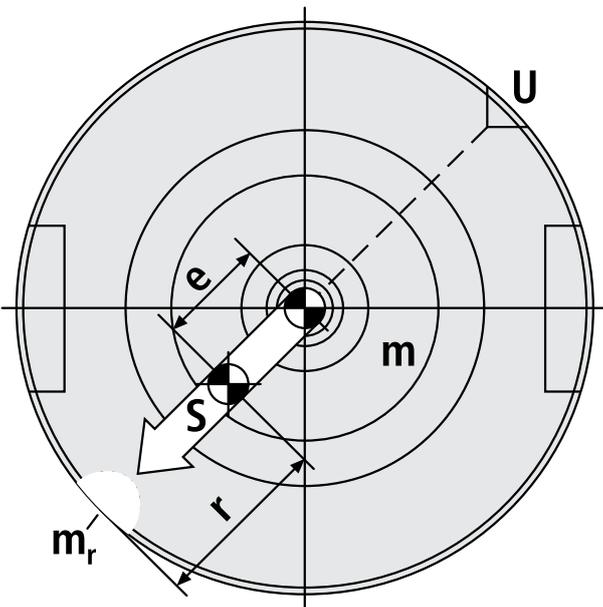

$$G = \frac{U \cdot 2 \cdot \pi \cdot n}{m \cdot 60} \iff U = \frac{G \cdot m \cdot 60}{2 \cdot \pi \cdot n}$$

$$U = \frac{2,5 \cdot 760 \cdot 60}{2 \cdot \pi \cdot 25,000} \implies U = 0.726 \text{ gmm}$$

$$e = \frac{0.726}{760} \implies e = 0.96 \text{ } \mu\text{m}$$

Remarks on the diagram: "S" = Mass axis

Calculation of remaining unbalanced mass based on the example above:

$$m_r = \frac{m \cdot e}{r} \implies m_r = \frac{760 \cdot 0.00096}{31.5} \implies m_r = 0.023\text{g}$$

Fine balancing of the arbor, therefore, minimizes the remaining unbalanced mass to 0.023 g (based on the arbor taper radius of 31.5 mm).

Your advantages – Why this issue is so important.

Balancing, in particular in conjunction with a high level of concentricity, reduces centrifugal forces and protects the machine spindle by reducing vibrations. This results in a very smooth-running tool, significantly increasing machining and workpiece quality, and facilitating better cutting parameters – both in HSC and conventional machining.

The Pokolm tool system

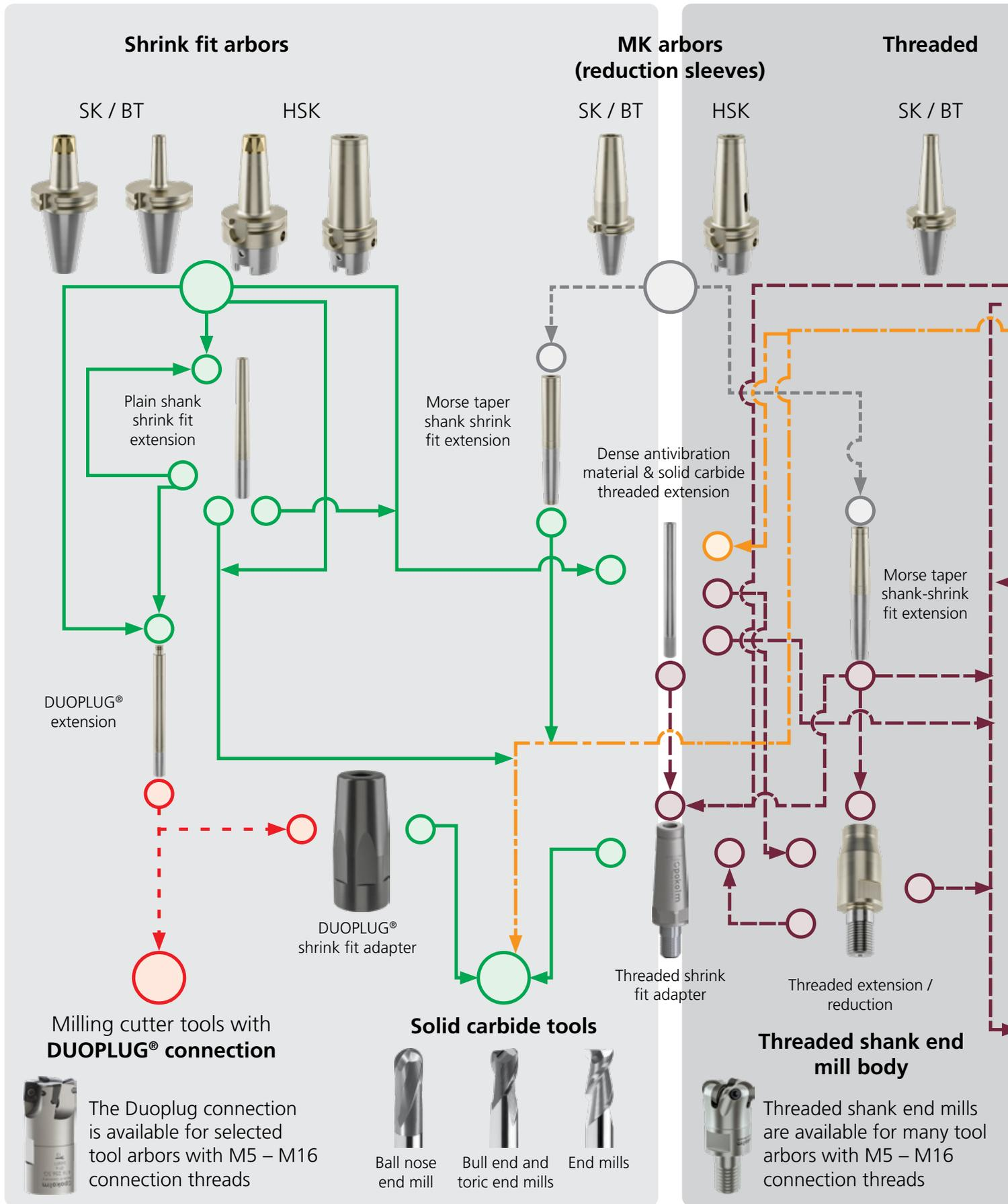

 Shrink fit connection
 Morse taper connection
 Threaded connection

 Shell-type connection
 ER collet connection

Arbors

HSK



ER collet arbors

SK / BT



HSK



Arbors for shell type milling cutters

SK / BT



HSK



Flat contact surface

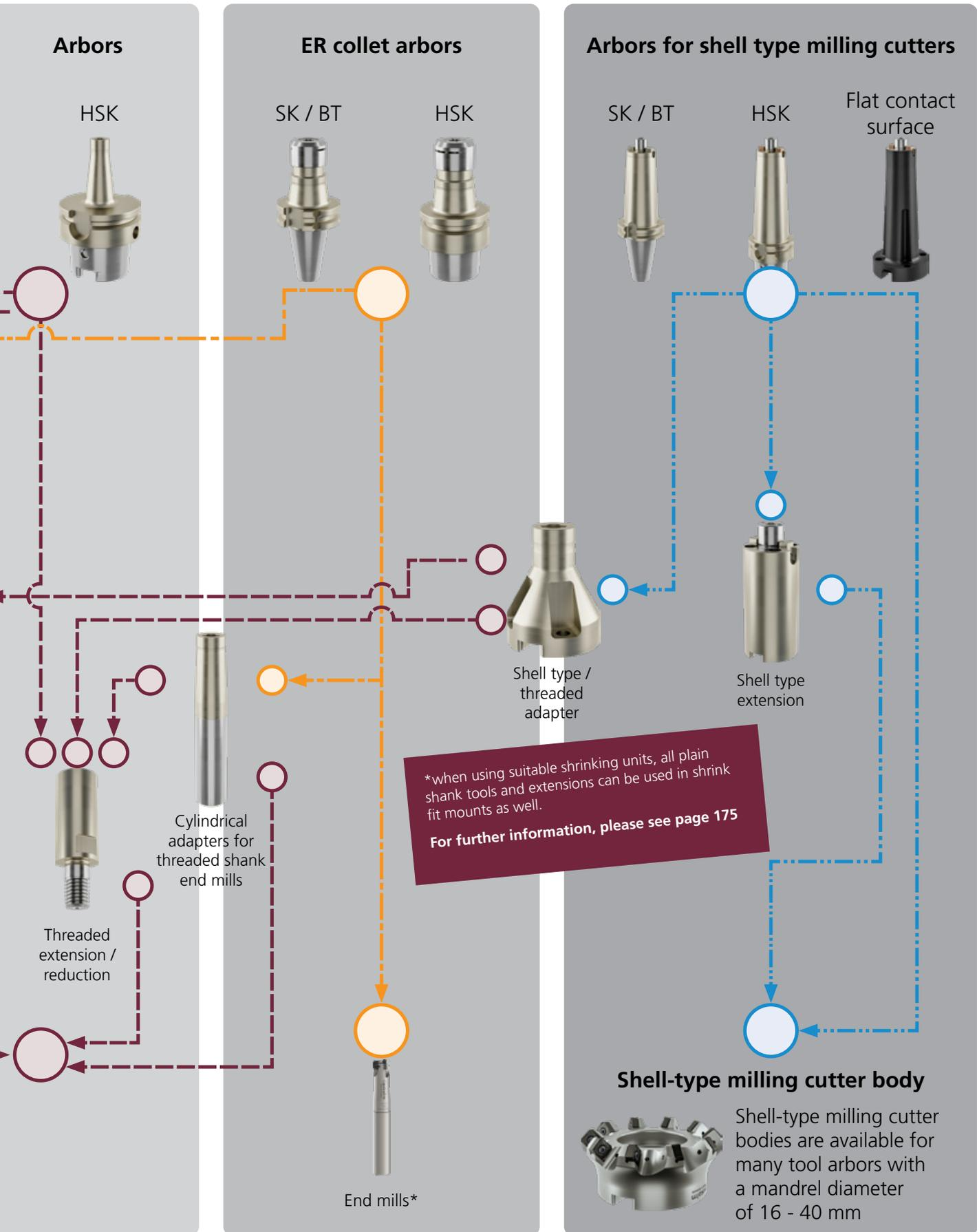

*when using suitable shrinking units, all plain shank tools and extensions can be used in shrink fit mounts as well.
For further information, please see page 175

Shell-type milling cutter body



Shell-type milling cutter bodies are available for many tool arbors with a mandrel diameter of 16 - 40 mm

Technology comparison

Threaded connection vs. Pokolm DuoPlug® connection

What sets the systems apart:

Pokolm threaded connection – the powerful standard

Pokolm threaded connection

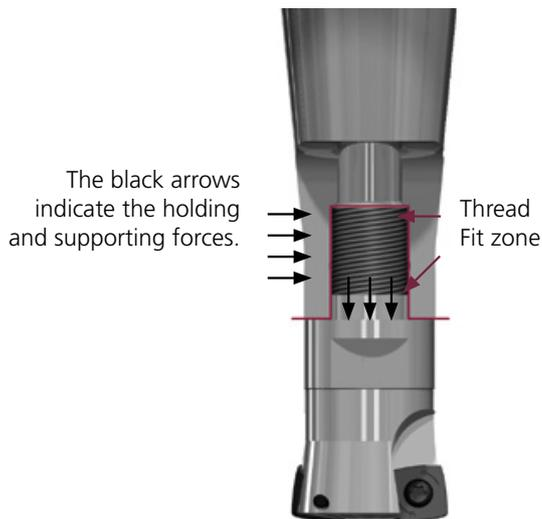

The standard threaded connection is produced with the highest tolerances using state of the art technology. Structural optimizations of the tool and arbor significantly improve the performance capabilities of the Pokolm thread connection system.

Benefits

- no undercut, avoiding a predetermined breaking point
- high-precision fit zone, and high-precision contact surface
- higher tensile strength and thermal stability by using custom materials with specialized hard coating
- for hundreds of tool changes
- optimized chamfer design on the milling arbors

Your benefits

- universal use for roughing and finishing operations
- high durability and red hardness
- lower tool costs thanks to longer service life
- significant increase in stability due to larger contact surface

Ideal applications

- standard option for milling operations in short and medium machining depths
- specifically for deep machining situations without vertical walls

The patented DuoPlug® system – the perfect improvement

Pokolm-DuoPlug® = shrink grip and screw fit

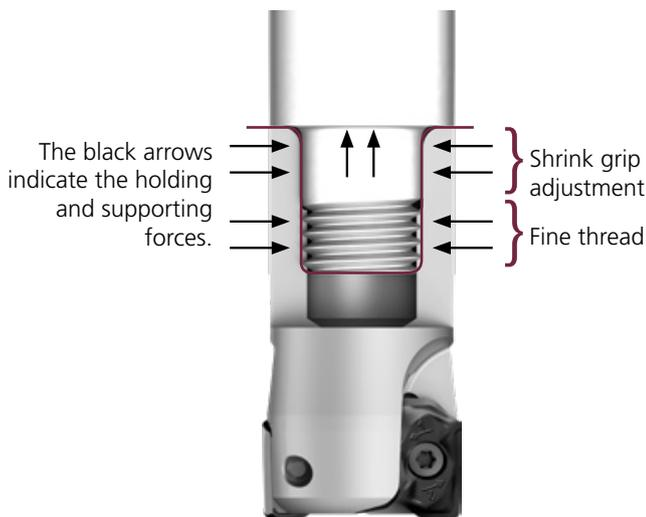

Benefits

- highest precision and concentricity
- optimal stability
- absolutely backlash-free tolerance fit seat thanks to shrink grip connection
- extremely precise and reproducible tool seat
- significantly better holding force than common threaded systems
- higher tensile strength and thermal stability by using custom materials with specialized hard coating

Your benefits

- increased process reliability
- longer tool life
- significant reduction in vibrations with long overhangs
- facilitates the highest precision in finishing operations
- high availability for the tool system and improved process reliability
- improved performance in roughing operations
- high durability and red hardness

Ideal applications

- high-precision finishing operations
- finishing and roughing work with long overhangs
- machining situations on vertical walls thanks to extremely narrow arbor system

The Pokolm **DuoPlug®** system offers optimal stability with the highest precision and concentricity. As a supplement to common screw-fitting tools, the holding forces between the tool and arbor system act over the full surface of the entire shrink grip connection, and large portions of the shrink grip thread. See the assembling instructions for the **DuoPlug®** in the "Technical Data" section for further information.

It's a fact:

DuoPlug® perfects threaded connections with significantly better holding force and the highest precision, at extremely narrow dimensions.

HSK forms and delivery versions

Form A – DIN 69 893-1

Form A is automatically exchangeable with grip (A) and indexing slots (B). The indexing slot allows for an oriented spindle stop. Design with bore (C) for manual activation of the clamping mechanism and central coolant feed.

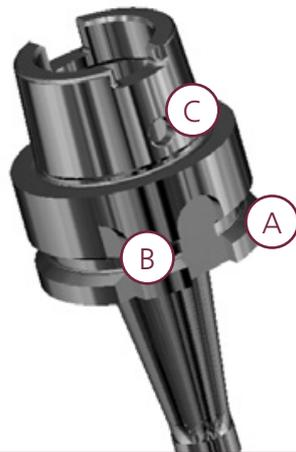

Form EC – in accordance with DIN 69 893-5

The basic design of Form EC is the same as that of Form E. The added driving slots (D), however, allow its use both in HSK version Form C and Form E. Version with bore (C) for manual activation of the clamping mechanism.



Form E – DIN 69 893-5

Form E is automatically exchangeable with grip slot (A). Upon request with bore (C) for manual activation of the clamping mechanism.



Form F – DIN 69 893-6

Form F is automatically exchangeable with grip slot (A). Version with bore (C) for manual activation of the clamping mechanism. To ensure a larger contact surface, the taper diameter (E) is smaller than the selected bore diameter (F).



The Pokolm arbor system

The optimal solution for your application

Arbor system	Advantages	Recommended applications
<p>1</p> <p>Arbors for thread connection, conical</p> 	<ul style="list-style-type: none"> • stable standard version • large variety of types and lengths, added flexibility thanks to extensions and reductions • improved stability through eliminating excess interfaces 	<ul style="list-style-type: none"> • machining situations in flat to deep contours for small tool diameters up to 42 mm
<p>2</p> <p>Arbors for thread connection, cylindrical</p> 	<ul style="list-style-type: none"> • slim design • improved stability through eliminating excess interfaces • added flexibility if needed thanks to extensions and reductions 	<ul style="list-style-type: none"> • moderate machining depths, in particular with deeper vertical walls for tool diameters up to 42 mm
<p>3</p> <p>Reduction sleeves with MK adapters</p> 	<ul style="list-style-type: none"> • MK adapters available as threaded and shrink grip variants for solid carbide tools • fast and flexible tool exchange • modular system for achieving large machining depths 	<ul style="list-style-type: none"> • for standard machining situations with normal stability and precision requirements, for tool diameters up to 42 mm
<p>4</p> <p>Arbors for shell type milling cutters</p> 	<ul style="list-style-type: none"> • stable variant, in particular for roughing and finishing operations in large diameter ranges, with a wide variety of types and lengths • improved stability through eliminating excess interfaces 	<ul style="list-style-type: none"> • flat to deep machining situations in pre-finishing to roughing for tool diameters from 42 mm to 125 mm and above
<p>5</p> <p>Arbors with flat contact surface</p> 	<ul style="list-style-type: none"> • extremely stable hold thanks to flat contact surface • good machining conditions at large depths • improved stability through eliminating excess interfaces 	<ul style="list-style-type: none"> • deep to extra-deep machining on SK50 tools with particularly high stability requirements for tool diameters from 52 mm to over 125 mm
<p>6</p> <p>Shrink grip arbors, standard design</p> 	<ul style="list-style-type: none"> • slim design with 3° pitch to the arbor collar • direct shrink gripping of all common cylindrical tool shanks • improved stability through eliminating excess interfaces • improved concentricity • can be combined with solid carbide and dense antivibration material adapters 	<ul style="list-style-type: none"> • machining situations in narrow spaces for solid carbide tools up to a 25 mm diameter, in combination with solid carbide or dense antivibration material adapters even up to a tool diameter of 42 mm

Arbor system	Advantages	Recommended applications
<p>7</p> <p>Shrink grip arbors, reinforced design</p> 	<ul style="list-style-type: none"> • version with 4.5° pitch to the arbor collar and reinforced shank • direct shrink gripping of all common cylindrical tool shanks • improved stability through eliminating excess interfaces • improved concentricity 	<ul style="list-style-type: none"> • machining with increased requirements for arbor stability for solid carbide tools up to a diameter of 20 mm
<p>8</p> <p>Arbors with shrink-grip DuoPlug® adapters</p> 	<ul style="list-style-type: none"> • extremely long and slim arbor combinations • greatest possible vibration reduction with solid carbide rod • DuoPlug® connection for the highest precision and concentricity • increased holding forces 	<ul style="list-style-type: none"> • machining at greater depths with cylindrical walls • roughing operations with high holding forces • finishing operations with the highest requirements for surface grade • up to a tool diameter of 25 mm
<p>9</p> <p>Arbors with shrink-grip dense antivibration material adapters</p> 	<ul style="list-style-type: none"> • long and slim arbor combinations • low vibration thanks to dense antivibration material • with threaded connection, no shrinking operations necessary. 	<ul style="list-style-type: none"> • machining at greater depths with cylindrical walls • for, narrow, deep molds and dies • Machining situations in which vibrations normally occur • for tool diameters up to 42 mm
<p>10</p> <p>Zero reach arbors</p> 	<ul style="list-style-type: none"> • due to direct shrink gripping of the DuoPlug®, solid carbide, or dense antivibration material adapter in the arbor cone, cylindrical machining is possible up to directly under the arbor collar. This provides significant added stability by reducing the distance between the tool and spindle 	<ul style="list-style-type: none"> • machining of especially deep cavities with vertical walls, both with limited space and limited Z travel paths, with high requirements for stability and low-vibration work
<p>11</p> <p>ER-20 precision collet chucks</p> 	<ul style="list-style-type: none"> • universal solution for direct clamping of all common cylindrical tool shanks, without a shrinking unit • also clamps "uneven" shank diameters and shanks smaller than 3 mm 	<ul style="list-style-type: none"> • for changing applications • for finishing, pre-finishing, and light roughing operations
<p>12</p> <p>Arbors with shrink-grip solid carbide adapters</p> 	<ul style="list-style-type: none"> • long and slim arbor combinations • low vibration, thanks to solid dense antivibration material • with threaded connection, no shrinking operations necessary. 	<ul style="list-style-type: none"> • machining at greater depths with cylindrical walls • for, narrow, deep molds and dies • Machining situations in which vibrations normally occur • for tool diameters up to 42 mm

*please note: Zero reach arbors cannot be ordered separately. They are shrunk at the factory with the corresponding solid or dense antivibration material adapter (please indicate the required adapter when placing your order) and delivered ready for use.

PRODUCT VARIETY IN THE HIGHEST QUALITY

Adapters,
extensions,
collets and
drill chucks

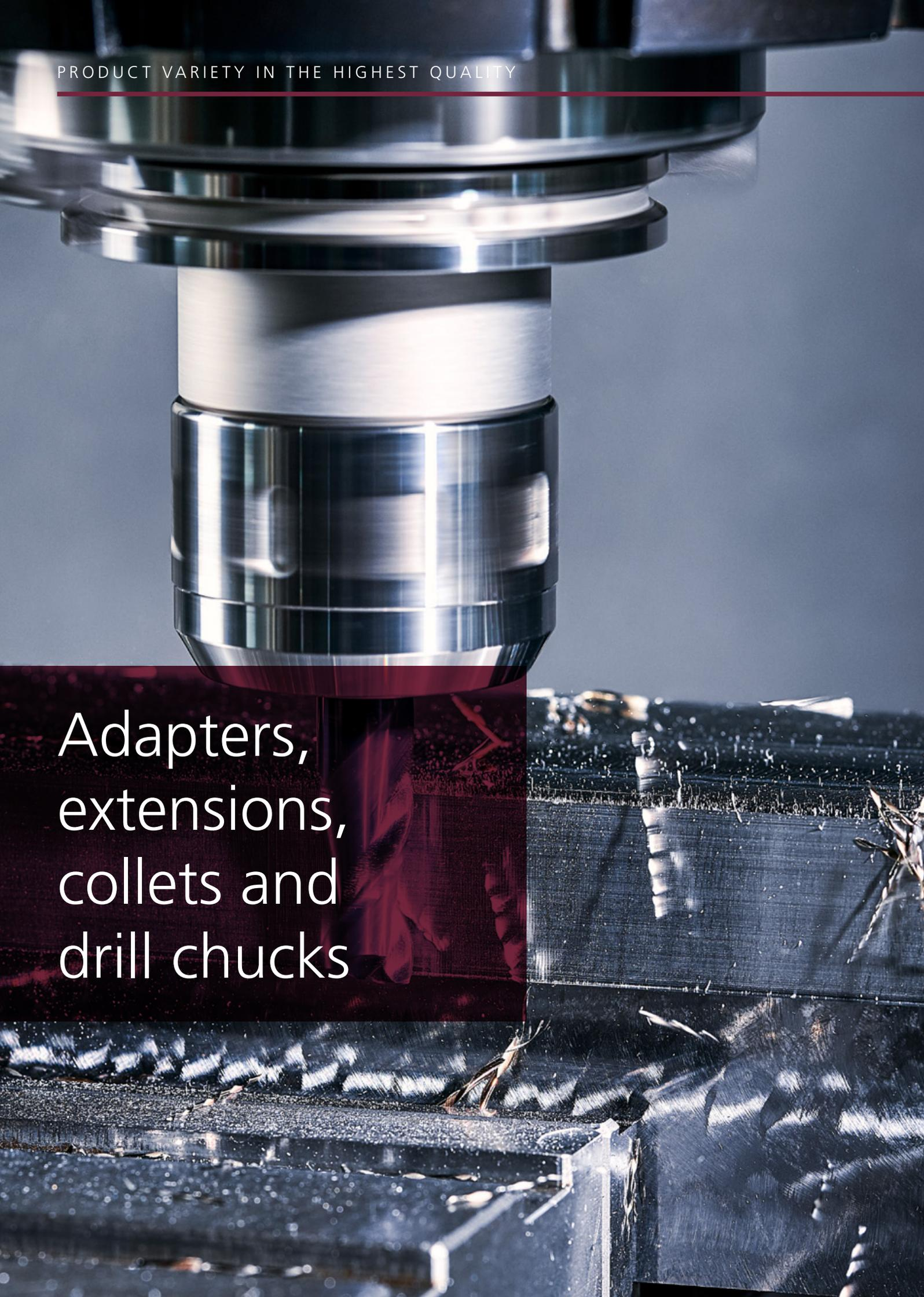

At a glance

	Page
Pokolm DuoPlug® solid carbide adapters	M 7 – M 16 26
Pokolm DuoPlug® shrink fit adapters	diam. 6 – 10 mm 28
Pokolm shrink fit extensions	diam. 3 – 12 mm 29
Pokolm threaded shrink fit adapters	diam. 6 – 12 mm 30
Solid carbide adapters – for threaded shank end mills	M 6 – M 16 31
Dense antivibration material adapters – for threaded shank end mills	M 8 – M 16 33
MK adapters – for threaded shank end mills	M 8 – M 16 35
MK adapters – for shrinking	diam. 6 – 16 mm 37
Pokolm extensions– for threaded shanks	M 8 – M 16 38
Pokolm reduction adapters – for threaded shanks	M 6 – M 12 39
Pokolm cyl. Shank – DIN 1835A	M 6 – M 16 40
Pokolm cyl. Shank – DIN 1835A	M 6 – M 16 41
Pokolm shell-type adapter – for insertion on shell-type milling cutters 42
Pokolm shell-type adapter – for threading on shell-type milling cutters 43
Precision collet chucks	ER 16 for diam. 1 – 10 mm 44
Precision collet chucks	ER 20 for diam. 1 – 12 mm 45
Drill chuck – threaded	M 16 46

Pokolm adapters, extensions, collets and drill chucks

Pokolm solid carbide adapters were developed for our patented Duoplug® system. They are especially suited for HSC, and deliver extreme precision thanks to a fit that is absolutely backlash-free, combined with the holding forces needed for roughing applications. All adapters have an internal coolant supply as a standard.

Pokolm shrink fit extensions have a cylindrical shank in accordance with DIN 1835A that makes them excellent for use in all commonly available collets, hydro expansion and power collet chucks. The products can also be used in shrink-grip arbors in some cases, using appropriate shrinking units.

Pokolm threaded shrink fit adapters are an excellent choice when troubleshooting machining for deep cavities. Their slim design allows access to narrow areas.

Pokolm shell-type adapters for insertion and threading are the fast, stable, and inexpensive alternative to custom manufacturing. All adapters are manufactured according to the Pokolm standard with smoothed contact and mating surfaces and an internal coolant supply option. To use the adapters, the base arbors must be fitted with 4 threaded bores.

ER collets from Pokolm are used to securely and quickly clamp tools with cylindrical shanks in combination with the matching collet chuck. Using Pokolm collet systems makes it possible to achieve a high level of concentricity for the individual tool. Our collets are certified in accordance with DIN 6499-B

CNC precision drill chucks from Pokolm can be used up to $n = 7,000/\text{min}$ and has an internal coolant supply. It stands out for its very short and slim design, and can be used for any direction of rotation.

Pokolm DuoPlug®

M 7 – M 16

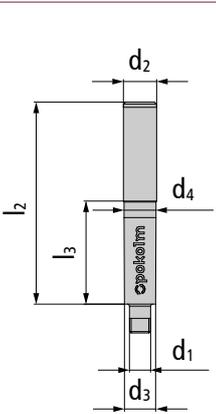

Characteristics:      

M 7 to M 16	Order no.	d ₁	l ₃	A	d ₃	d ₄	d ₂	DIN / shape	l ₂	l ₁	
	M 7	20 07 603	7	20	–	10.8	11.4	12	–	68	–
	40 07 603	7	40	–	10.8	11.4	12	–	88	–	
	60 07 603/12	7	60	–	10.8	11.4	12	–	108	–	
	80 07 603/12	7	80	–	10.8	11.4	12	–	128	–	
	100 07 603	7	100	–	10.8	15.9	16	–	148	–	
	120 07 603	7	120	–	10.8	15.9	16	–	168	–	
M 10	25 10 603	10	25	–	15	15.4	16	–	73	–	
	50 10 603	10	50	–	15	15.4	16	–	98	–	
	75 10 603	10	75	–	15	15.4	16	–	123	–	
	100 10 603	10	100	–	15	15.4	16	–	148	–	
	125 10 603	10	125	–	15	15.4	16	–	173	–	
	150 10 603	10	150	–	15	15.4	16	–	200	–	
M 12	25 12 603	12	25	–	18.5	19.4	20	–	75	–	
	50 12 603	12	50	–	18.5	19.4	20	–	100	–	
	75 12 603	12	75	–	18.5	19.4	20	–	125	–	
	100 12 603	12	100	–	18.5	19.4	20	–	150	–	
	125 12 603	12	125	–	18.5	19.4	20	–	175	–	
	150 12 603	12	150	–	18.5	19.4	20	–	200	–	
	175 12 603	12	175	–	18.5	19.4	20	–	225	–	

Characteristics:



M 7 to M 16	Order no.	d ₁	l ₃	A	d ₃	d ₄	d ₂	DIN / shape	l ₂	l ₁	
	M 16	25 16 603	16	25	-	23.4	24.4	25	-	81	-
	50 16 603	16	50	-	23.4	24.4	25	-	106	-	
	75 16 603	16	75	-	23.4	24.4	25	-	131	-	
	100 16 603	16	100	-	23.4	24.4	25	-	156	-	
	125 16 603	16	125	-	23.4	24.4	25	-	181	-	
	150 16 603	16	150	-	23.4	24.4	25	-	206	-	
	175 16 603	16	175	-	23.4	24.4	25	-	231	-	
	200 16 603	16	200	-	23.4	24.4	25	-	256	-	

<2/2

Pokolm DuoPlug® shrink fit adapter

Diameter 6 to 10 mm



Characteristics:    

Diameter 6 to 10 mm	Order no.	d ₁	l ₃	A	d ₃	d ₄	d ₂	DIN / shape	l ₂	l ₁
Diameter 6 mm	35 06 10 SG	6	35	–	12	15	10	–	–	–
	43 06 12 SG	6	43	–	12	18.5	12	–	–	–
	45 06 12 SG	6	45	–	12	18.5	12	–	–	–
	50 06 16 SG	6	50	–	12	23.5	16	–	–	–
Diameter 8 mm	45 08 12 SG	8	45	–	16	18.5	12	–	–	–
	50 08 16 SG	8	50	–	16	23.5	16	–	–	–
Diameter 10 mm	50 10 16 SG	10	50	–	20	23.5	16	–	–	–

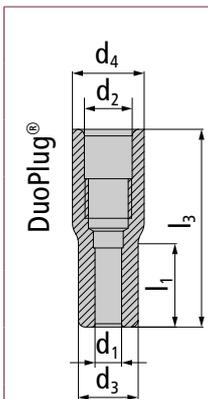

Pokolm shrink fit extensions

Diameter 3 to 12 mm



Characteristics:   

Diameter 3 to 12 mm	Order no.	d_1	l_3	A	d_3	d_4	d_2	DIN / shape	l_2	l_1
Diameter 3 mm	112 03 604 S.01	3	66.8	-	9	16	16	-	160	-
	115 03 604 S.01	3	28.6	-	9	12	12	-	160	-
Diameter 4 mm	112 04 604 S.01	4	66.8	-	10.5	16	16	-	160	-
	115 04 604 S.01	4	14.31	-	10.5	12	12	-	160	-
Diameter 6 mm	112 06 604 S	6	47.7	-	11	16	16	-	160	-
	115 06 604 S	6	11.45	-	11	12	12	-	160	-
Diameter 8 mm	110 08 604 S	8	66.8	-	13	20	20	-	160	-
	112 08 604 S	8	28.6	-	13	16	16	-	160	-
Diameter 10 mm	110 10 604 S	10	47.7	-	15	20	20	-	160	-
Diameter 12 mm	104 12 604 S	12	76.3	-	17	25	25	-	160	-

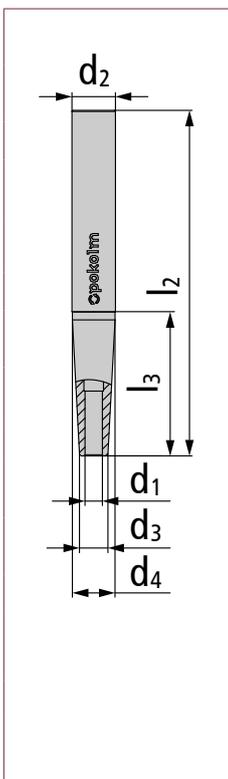

Pokolm threaded shrink fit adapter

Diameter 6 to 12 mm

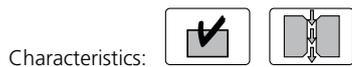

Diameter 6 to 12 mm	Order no.	d_1	l_3	A	d_3	d_4	d_2	DIN / shape	l_2	l_1
Diameter 6 mm	40 06 10 784 S	6	40	–	12	18	10	–	–	7.8
	40 06 12 784 S	6	40	–	12	21	12	–	–	7.8
	40 06 16 784 S	6	40	–	12	29	16	–	–	7.8
Diameter 8 mm	40 08 10 784 S	8	40	–	16	18	10	–	–	7.8
	40 08 12 784 S	8	40	–	16	21	12	–	–	7.8
	40 08 16 784 S	8	40	–	16	29	16	–	–	7.8
Diameter 10 mm	60 10 10 784 S	10	60	–	18	18	10	–	–	7.8
	60 10 12 784 S	10	60	–	20	21	12	–	–	7.8
	60 10 16 784 S	10	60	–	20	29	16	–	–	7.8
Diameter 12 mm	60 12 12 784 S	12	60	–	21	21	12	–	–	7.8
	60 12 16 784 S	12	60	–	24	29	16	–	–	7.8

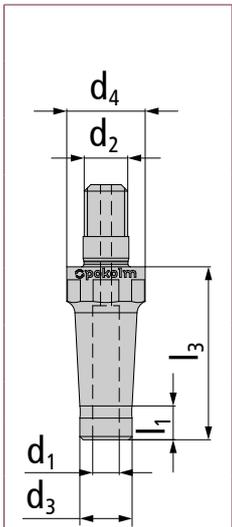

Note: Pokolm threaded shrink fit adapters can also be requested in additional diameter sizes.

Solid carbide adapters – for threaded shank end mills

M 6 – M 16



Characteristics:    

M 6 to M 16	Order no.	d ₁	l ₃	A	d ₃	d ₄	d ₂	DIN / shape	l ₂	l ₁
M 6	20 06 606/10 ZYL	6	20	–	9.5	9.5	10	–	60	–
	20 06 606/12 ZYL	6	20	–	11.5	11.5	12	–	65	–
	40 06 606/10 ZYL	6	40	–	9.5	9.5	10	–	80	–
	40 06 606/12 ZYL	6	40	–	11.5	11.5	12	–	85	–
	60 06 606/10 ZYL	6	60	–	9.5	9.5	10	–	100	–
	60 06 606/12 ZYL	6	60	–	11.5	11.5	12	–	105	–
	80 06 606/10 ZYL	6	80	–	9.5	9.5	10	–	120	–
	80 06 606/12 ZYL	6	80	–	11.5	11.5	12	–	125	–
	100 06 606/12 ZYL	6	100	–	11.5	11.5	12	–	145	–
M 8	40 08 606	8	40	–	14.2	15.3	16	–	88	9
	60 08 606	8	60	–	14.2	15.3	16	–	108	9
	80 08 606	8	80	–	14.2	15.3	16	–	128	9
	100 08 606	8	100	–	14.2	15.3	16	–	148	9
	120 08 606	8	120	–	14.2	15.3	16	–	168	9
M 10	60 10 606	10	60	–	18.5	19.3	20	–	110	9
	80 10 606	10	80	–	18.5	19.3	20	–	130	9
	100 10 606	10	100	–	18.5	19.3	20	–	150	9
	120 10 606	10	120	–	18.5	19.3	20	–	170	9
	140 10 606	10	140	–	18.5	19.3	20	–	190	9

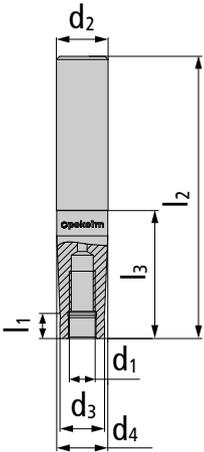

Solid carbide adapters – for threaded shank end mills

M 6 – M 16



Characteristics:    

M 6 to M 16	Order no.	d ₁	l ₃	A	d ₃	d ₄	d ₂	DIN / shape	l ₂	l ₁
M 12	80 12 606	12	80	–	23	24.3	25	–	136	9
	100 12 606	12	100	–	23	24.3	25	–	156	9
	120 12 606	12	120	–	23	24.3	25	–	176	9
	140 12 606	12	140	–	23	24.3	25	–	196	9
	160 12 606	12	160	–	23	24.3	25	–	216	9
M 16	100 16 606/32	16	100	–	29	31.5	32	–	160	9
	150 16 606/32	16	150	–	29	31.5	32	–	210	9
	200 16 606/32	16	200	–	29	31.5	32	–	260	9
	250 16 606/32	16	250	–	29	31.5	32	–	310	9
	300 16 606/32	16	300	–	29	31.5	32	–	360	9

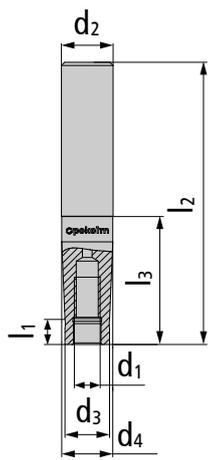

Dense antivibration material adapters – for threaded shank end mills

M 8 – M 16



Characteristics:    

M 8 to M 12	Order no.	d ₁	l ₃	A	d ₃	d ₄	d ₂	DIN / shape	l ₂	l ₁
M 8	40 08 601	8	40	–	14.2	15.3	16	–	88	9
	60 08 601	8	60	–	14.2	15.3	16	–	108	9
	80 08 601	8	80	–	14.2	15.3	16	–	128	9
	100 08 601	8	100	–	14.2	15.3	16	–	148	9
	120 08 601	8	120	–	14.2	15.3	16	–	168	9
	150 08 601	8	150	–	14.2	15.3	16	–	198	9
M 10	60 10 601	10	60	–	18.5	19.3	20	–	110	9
	80 10 601	10	80	–	18.5	19.3	20	–	130	9
	100 10 601	10	100	–	18.5	19.3	20	–	150	9
	120 10 601	10	120	–	18.5	19.3	20	–	170	9
	140 10 601	10	140	–	18.5	19.3	20	–	190	9
M 12	50 12 601	12	50	–	23	24.3	25	–	106	9
	75 12 601	12	75	–	23	24.3	25	–	131	9
	100 12 601	12	100	–	23	24.3	25	–	156	9
	125 12 601	12	125	–	23	24.3	25	–	181	9
	150 12 601	12	150	–	23	24.3	25	–	206	9
	175 12 601	12	175	–	23	24.3	25	–	231	9

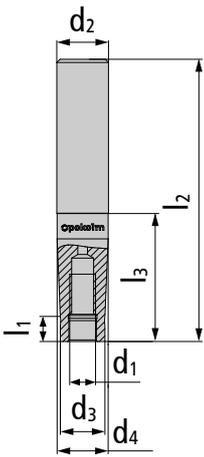

1/2 >

Dense antivibration material adapters – for threaded shank end mills

M 8 – M 16



Characteristics:

-
-
-
-

M 8 to M 16	Order no.	d ₁	l ₃	A	d ₃	d ₄	d ₂	DIN / shape	l ₂	l ₁
-------------	-----------	----------------	----------------	---	----------------	----------------	----------------	-------------	----------------	----------------

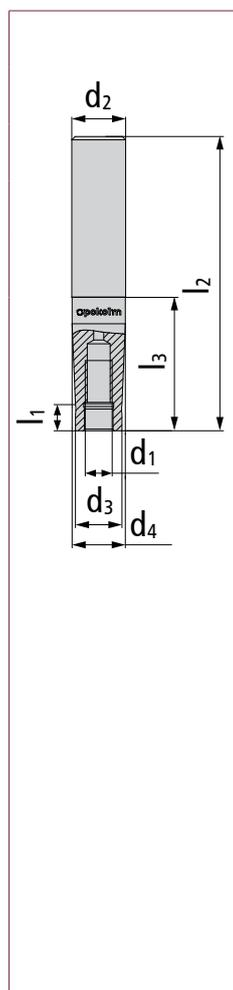

M 16	100 16 601/32	16	100	–	29	31.5	32	–	160	9
	150 16 601/32	16	150	–	29	31.5	32	–	210	9
	200 16 601/32	16	200	–	29	31.5	32	–	260	9
	250 16 601/32	16	250	–	29	31.5	32	–	310	9
	300 16 601/32	16	300	–	29	31.5	32	–	360	9

<2/2

MK adapters – for threaded shank end mills

M 8 – M 16



Characteristics:   

M 8 to M 16	Order no.	d ₁	l ₃	A	d ₃	d ₄	d ₂	DIN / shape	l ₂	l ₁
M 8	20 08 MK2	8	20	–	13.8	18	2	–	–	–
	40 08 MK2	8	40	–	13.8	18	2	–	–	8.5
	60 08 MK2	8	60	–	13.8	18	2	–	–	8.5
	80 08 MK3	8	80	–	13.8	24	3	–	–	8.5
	100 08 MK3	8	100	–	13.8	24.1	3	–	–	8.5
M 10	20 10 MK2	10	20	–	18	18	2	–	–	–
	40 10 MK2	10	40	–	18	18	2	–	–	–
	60 10 MK2	10	60	–	18	18	2	–	–	–
	80 10 MK3	10	80	–	18	24	3	–	–	8.5
	100 10 MK3	10	100	–	18	23.6	3	–	–	8.5
M 12	30 12 MK3	12	30	–	21	23.6	3	–	–	8.5
	45 12 MK3	12	45	–	21	24.1	3	–	–	8.5
	60 12 MK3	12	60	–	21	24.1	3	–	–	8.5
	75 12 MK3	12	75	–	21	24.1	3	–	–	8.5
	95 12 MK3	12	95	–	21	24.1	3	–	–	8.5
	120 12 MK4	12	120	–	21	31.6	4	–	–	8.5

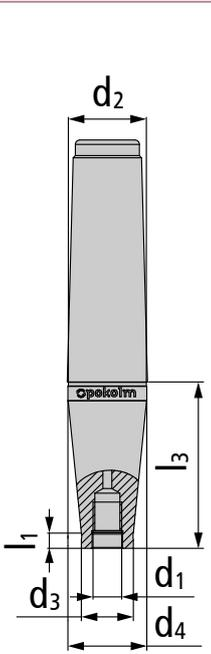

MK adapters – for threaded shank end mills

M 8 – M 16

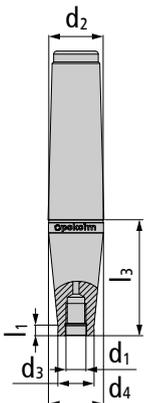

Characteristics:   

M 8 to M 16	Order no.	d ₁	l ₃	A	d ₃	d ₄	d ₂	DIN / shape	l ₂	l ₁	
	M 16	35 16 MK4	16	35	–	29	31.5	4	–	–	8.5
	50 16 MK4	16	50	–	29	31.6	4	–	–	8.5	
	65 16 MK4	16	65	–	29	31.6	4	–	–	8.5	
	80 16 MK4	16	80	–	29	31.6	4	–	–	8.5	
	95 16 MK4	16	95	–	29	31.5	4	–	–	8.5	
	120 16 MK5	16	120	–	29	44.5	5	–	–	8.5	
	150 16 MK5	16	150	–	29	44.7	5	–	–	8.5	
	180 16 MK5	16	180	–	29	44	5	–	–	8.5	

MK adapters – for shrink gripping

Diameter 6 to 16 mm



Characteristics:   

Diameter 6 to 16 mm	Order no.	d_1	l_3	A	d_3	d_4	d_2	DIN / shape	l_2	l_1
Diameter 6 mm	50 06 MK3 S	6	50	–	12	23.5	3	–	–	7.8
	100 06 MK3 S	6	100	–	12	24	3	–	–	7.8
	150 06 MK3 S	6	150	–	12	24	3	–	–	7.8
Diameter 8 mm	50 08 MK3 S	8	50	–	16	24	3	–	–	7.8
	100 08 MK3 S	8	100	–	16	24	3	–	–	7.8
	150 08 MK3 S	8	150	–	16	24	3	–	–	7.8
	200 08 MK5 S	8	200	–	16	44.5	5	–	–	7.8
Diameter 10 mm	50 10 MK3 S	10	50	–	20	24	3	–	–	7.8
	100 10 MK3 S	10	100	–	20	24	3	–	–	7.8
	150 10 MK4 S	10	150	–	20	32	4	–	–	7.8
	200 10 MK5 S	10	200	–	20	44.2	5	–	–	7.8
Diameter 12 mm	50 12 MK3 S	12	50	–	24	24	3	–	–	7.8
	100 12 MK3 S	12	100	–	24	24	3	–	–	–
	150 12 MK4 S	12	150	–	24	31	4	–	–	7.8
	200 12 MK5 S	12	200	–	24	44.5	5	–	–	7.8
Diameter 16 mm	150 16 MK4 S	16	150	–	32	32	4	–	–	7.8
	200 16 MK5 S	16	200	–	32	44.2	5	–	–	7.8

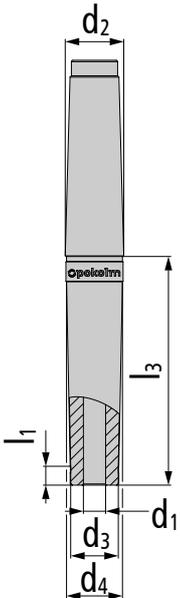

Pokolm extensions – for threaded shanks

M 8 – M 16



M 8 to M 16	Order no.	d ₁	l ₃	A	d ₃	d ₄	d ₂	DIN / shape	l ₂	l ₁
M 8	08 40 780	8	40	–	13.8	13.8	8	–	–	–
	08 60 780	8	60	–	13.8	13.8	8	–	–	–
M 10	10 40 780	10	40	–	18	18	10	–	–	–
	10 60 780	10	60	–	18	18	10	–	–	–
M 12	12 40 780	12	40	–	21	21	12	–	–	–
	12 60 780	12	60	–	21	21	12	–	–	–
M 16	16 40 780	16	40	–	29	29	16	–	–	–
	16 60 780	16	60	–	29	29	16	–	–	–

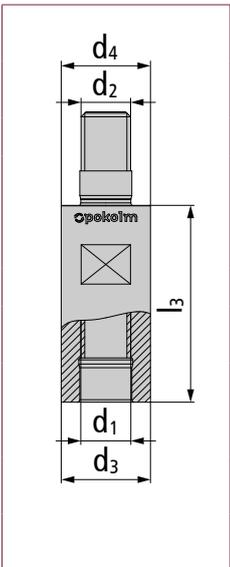

Pokolm reductions – for threaded shanks

M 6 – M 12

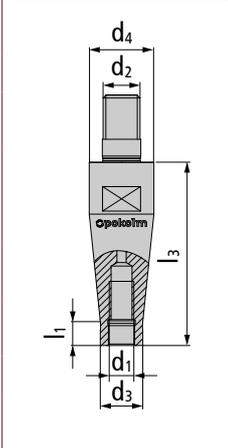

Characteristics:  

M 6 to M 12	Order no.	d_1	l_3	A	d_3	d_4	d_2	DIN / shape	l_2	l_1	
	M 6	08 20 781	6	20	–	9.75	13.8	8	–	–	7.8
	M 8	10 40 781	8	40	–	13.8	18	10	–	–	7.8
12 60 781		8	60	–	13.8	21	12	–	–	7.8	
M 10	12 40 781	10	40	–	18	21	12	–	–	7.8	
	16 60 781	10	60	–	18	29	16	–	–	7.8	
M 12	16 40 781	12	40	–	21	29	16	–	–	7.8	

Pokolm plain shank – DIN 1835A

M 6 – M 16



Characteristics:   

M 6 to M 16	Order no.	d ₁	l ₃	A	d ₃	d ₄	d ₂	DIN / shape	l ₂	l ₁
M 6	20 06 600/10 G	6	20	–	9.75	9.8	10	–	60	7.8
	20 06 600/12 G	6	20	–	11.5	11.8	12	–	65	7.8
	40 06 600/10 G	6	40	–	9.75	9.8	10	–	80	7.8
	40 06 600/12 G	6	40	–	11.5	11.8	12	–	85	7.8
M 8	20 16 600 G	8	20	–	13.8	15.8	16	–	68	7.8
	40 16 600 G	8	40	–	13.8	15.8	16	–	88	7.8
M 10	25 20 600 G	10	25	–	18	19.8	20	–	75	7.8
	45 20 600 G	10	45	–	18	19.8	20	–	95	7.8
M 12	30 25 600 G	12	30	–	21	24.8	25	–	86	7.8
	50 25 600 G	12	50	–	21	24.8	25	–	106	7.8
M 16	50 32 600 G	16	50	–	29	31.8	32	–	110	7.8

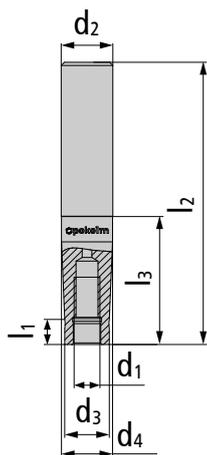

Pokolm plain shank – DIN 1835B

M 6 – M 16



Characteristics:

M 6 to M 16	Order no.	d_1	l_3	A	d_3	d_4	d_2	DIN / shape	l_2	l_1
M 6	20 06 600/10	6	20	–	9.75	9.8	10	–	60	7.8
	20 06 600/12	6	20	–	11.5	11.8	12	–	65	7.8
	40 06 600/10	6	40	–	9.75	9.8	10	–	80	7.8
	40 06 600/12	6	40	–	11.5	11.8	12	–	85	7.8
M 8	20 16 600	8	20	–	13.8	15.8	16	–	68	7.8
	40 16 600	8	40	–	13.8	15.8	16	–	88	7.8
M 10	25 20 600	10	25	–	18	19.8	20	–	75	7.8
	45 20 600	10	45	–	18	19.8	20	–	95	7.8
M 12	30 25 600	12	30	–	21	24.8	25	–	86	7.8
	50 25 600	12	50	–	21	24.8	25	–	106	7.8
M 16	50 32 600	16	50	–	29	31.8	32	–	110	7.8

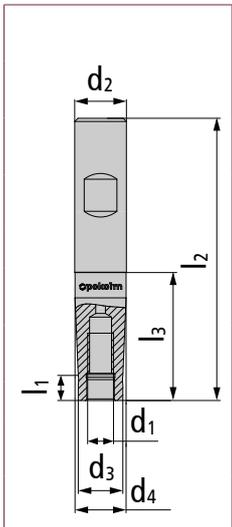

Pokolm shell-type adapters – for insertion

for shell-type milling cutters



for shell-type milling cutters	Order no.	d_1	l_3	A	d_3	d_4	d_2	DIN / shape	l_2	l_1
	Bore diam. 22 mm	50 22 782	22	50	–	48	48	22	–	–
		100 22 782	22	100	–	48	48	22	–	–
Accessories	DRIVING10X8	Driving block 10 x 8								> Page 161
	M4X10	Screw for driving block 10 x 8								> Page 160
	M6X55	Cheese-head screw								> Page 160
	M10X35	Screw M10X35								> Page 161
	Bore diam. 27 mm	50 27 782	27	50	–	62	62	27	–	–
		100 27 782	27	100	–	62	62	27	–	–
Accessories	DRIVING12X12/2	Driving block 12 x 12								> Page 161
	M5X16	Screw for driving block 12 x 12 and 14 x 14								> Page 160
	M8X55	Cheese-head screw								> Page 160
	M12X35	Screw M12X35								> Page 161

The scope of delivery includes 4 cheese-head screws for mounting the adapter.

Note: To use the Pokolm shell-type adapter, the base arbors must be fitted with 4 threaded bores!
This must be included in the order, and is implemented by additionally ordering the bores under the item number: 4XGEB0-AUF

Pokolm shell-type adapter – for threaded shanks

for threaded shank end mills



for threaded shank end mills		Order no.	d_1	l_3	A	d_3	d_4	d_2	DIN / shape	l_2	l_1
M 10	60 22 M10 783	M 10	60	–	–	18	48	22	–	–	12
	100 22 M10 783	M 10	100	–	–	18	48	22	–	–	12
Accessories	M6X25		Cheese-head screw		> Page 160						
M 10	60 27 M10 783	M 10	60	–	–	18	62	27	–	–	12
	100 27 M10 783	M 10	100	–	–	18	62	27	–	–	12
Accessories	M8X25		Cheese-head screw		> Page 160						
M 12	60 22 M12 783	M 12	60	–	–	21	48	22	–	–	12
	100 22 M12 783	M 12	100	–	–	21	48	22	–	–	12
Accessories	M6X25		Cheese-head screw		> Page 160						
M 12	60 27 M12 783	M 12	60	–	–	21	62	27	–	–	12
	100 27 M12 783	M 12	100	–	–	21	62	27	–	–	12
Accessories	M8X25		Cheese-head screw		> Page 160						
M 16	60 22 M16 783	M 16	60	–	–	29	48	22	–	–	12
	100 22 M16 783	M 16	100	–	–	29	48	22	–	–	12
Accessories	M6X25		Cheese-head screw		> Page 160						
M 16	60 27 M16 783	M 16	60	–	–	29	62	27	–	–	12
	100 27 M16 783	M 16	100	–	–	29	62	27	–	–	12
	100 27 M16 783-2	M 16	100	–	–	32	62	27	–	–	–
Accessories	M8X25		Cheese-head screw		> Page 160						

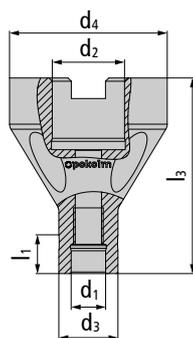

Precision collet chucks

ER 16 | for diam. 1– 10 mm

DIN ISO 15488 Form B | clamping range (mm) or tolerance: 1 | Concentricity: 5 µm

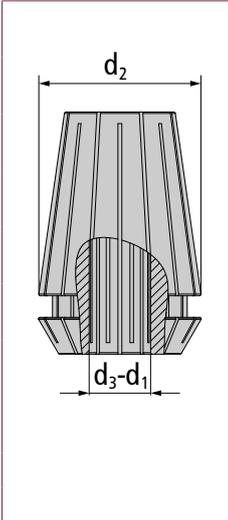

Characteristics:  

ER 16 diam. 1 – 10 mm	Order no.	d ₁	l ₃	A	d ₃	d ₄	d ₂	DIN / shape	l ₂	l ₁	
	ER16 1-2	2	–	–	1	–	16	–	–	–	
	ER16 2-3	3	–	–	2	–	16	–	–	–	
	ER16 3-4	4	–	–	3	–	16	–	–	–	
	ER16 4-5	5	–	–	4	–	16	–	–	–	
	ER16 5-6	6	–	–	5	–	16	–	–	–	
	ER16 7-8	8	–	–	7	–	16	–	–	–	
	ER16 8-9	9	–	–	8	–	16	–	–	–	
	ER16 9-10	10	–	–	9	–	16	–	–	–	
Accessories	ER16 001	Tightning nut ER 16							> Page 161		
	16 501	Collet chuck wrench for ER 16 tightening nut							> Page 161		

Precision collet chucks

ER 20 | for diam. 1– 12 mm

DIN ISO 15488 Form B | clamping range (mm) or tolerance: 1 | Concentricity: 5 µm

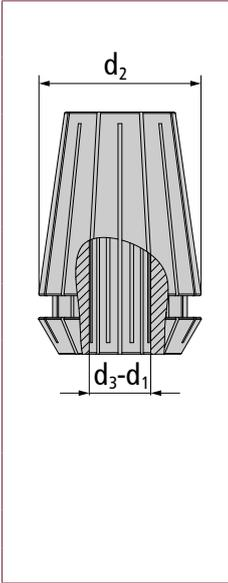

Characteristics:  

ER 20 diam. 1 – 12 mm	Order no.	d ₁	l ₃	A	d ₃	d ₄	d ₂	DIN / shape	l ₂	l ₁	
	ER20 0.5-1	1	–	–	0.5	–	20	–	–	–	
	ER20 1-2	2	–	–	1	–	20	–	–	–	
	ER20 2-3	3	–	–	2	–	20	–	–	–	
	ER20 3-4	4	–	–	3	–	20	–	–	–	
	ER20 4-5	5	–	–	4	–	20	–	–	–	
	ER20 5-6	6	–	–	5	–	20	–	–	–	
	ER20 7-8	8	–	–	7	–	20	–	–	–	
	ER20 9-10	10	–	–	9	–	20	–	–	–	
ER20 11-12	12	–	–	11	–	20	–	–	–		
Accessories	ER20 001	Tightning nut							> Page 161		
	20 501	Collet chuck wrench for ER 20 tightening nut							> Page 161		

Drill chucks – threaded

M 16



Characteristics:   

M 16	Order no.	d ₁	l ₃	A	d ₃	d ₄	d ₂	DIN / shape	l ₂	l ₁
------	-----------	----------------	----------------	---	----------------	----------------	----------------	-------------	----------------	----------------

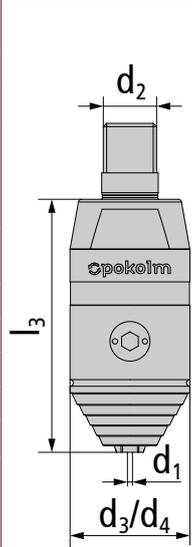
	Diam. 0.3-8 mm	BF 0.3-8 M16 IC	8	75	–	36	36	16	–	–	–
	Accessories	HEXA 4T	HEXA 4T		> Page 161						
		BF08DS04	Gasket 0804		> Page 163						
		BF08DS08	Gasket 0808		> Page 163						
		BF08MW	Wrench 08		> Page 163						
Diam. 0.5-13 mm	BF 0.5-13 M16 IC	13	100	–	50	50	16	–	–	–	
Accessories	HEXA 6T	HEXA 6T		> Page 161							
	BF13DS06	Gasket 1306		> Page 163							
	BF13DS13	Gasket 1313		> Page 163							
	BF13MW	Wrench 13/16		> Page 163							
Diam. 2.5-16 mm	BF 2.5-16 M16 IC	16	100	–	50	50	16	–	–	–	
Accessories	HEXA 6T	HEXA 6T		> Page 161							
	BF16DS06	Gasket 1606		> Page 163							
	BF16DS16	Gasket 1616		> Page 163							
	BF13MW	Wrench 13/16		> Page 163							

Drill chuck includes gasket and Allen wrench



PRODUCT VARIETY WITH THE HIGHEST PRECISION

Hollow shank taper HSK

At a glance

		Page
HSK 25 Form E	for shrinking.....	52
	HSC precision collet chucks ER 16.....	53
HSK 32 Form E	for shrinking.....	54
	HSC precision collet chucks ER 20.....	55
HSK 40 Form E	for threaded shank end mills	56
	for shrinking.....	57
	Drill chucks.....	58
	HSC precision collet chucks ER 20.....	59
HSK 40 Form EC	for shrinking.....	60
HSK 50 Form E	for threaded shank end mills	61
	for shrinking.....	62
	Drill chucks.....	64
	HSC precision collet chucks ER 20.....	65
	for shrinking CoolCap®	66
HSK 63 Form A	for threaded shank end mills	68
	for threaded shank end mills cylindrical.....	70
	for shrinking.....	71
	for shrinking reinforced design	74
	for shrinking CoolCap®	75
	for Weldon shank CoolCap®.....	77
	for shell-type milling cutters	78
	for shell-type milling cutters (vibration-dampened).....	80
	Drill chucks.....	81
	for morse tapers with tangs.....	82
HSC precision collet chucks ER 20.....	83	
HSK 100 Form A	for threaded shank end mills	84
	for shrinking.....	86
	for shrinking CoolCap®.....	87
	for Weldon shank CoolCap®.....	88
	for shell-type milling cutters	89
	for shell-type milling cutters (vibration-dampened).....	91
Drill chucks.....	93	

HOLLOW SHANK TAPER HSK



Pokolm hollow shaft tapers

Features and advantages:

- Wide range of variants available as a standard
- HSK 25 – HSK 100 arbors available
- Thanks to complete in-house production, custom designs can even be created for your application.
- Shank tolerance H6
- High balancing precision
- Suitable for HSS and solid carbide tools
- Suitable for coolants and MMS
- Extended shrink adjustment for optimal holding forces
- Hardness 52-54 HRC
- Arbors made of high temperature-resistant material

HSK 25 form E

for shrinking



Characteristics:   **HSC** **Form E** **DIN 69893** **G 2,5 40.000**

for shrink-fitting	Order no.	d_1	l_3	A	d_3	d_4	d_2	DIN / shape	l_2	l_1
--------------------	-----------	-------	-------	---	-------	-------	-------	-------------	-------	-------

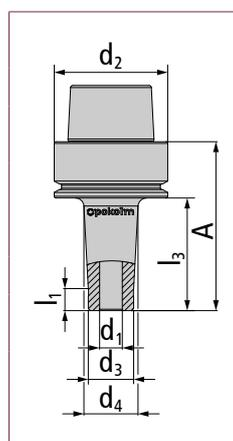

Diameter 3 mm	40 03 E25 S.01	3	40	50	9	14	25	Form E	–	7.8
Diameter 4 mm	40 04 E25 S.01	4	40	50	10.5	13.9	25	Form E	–	7.8
Diameter 6 mm	40 06 E25 S	6	40	50	12	15.4	25	Form E	–	7.8
Diameter 8 mm	40 08 E25 S	8	40	50	16	19	25	Form E	–	7.8
Diameter 10 mm	40 10 E25 S	10	40	50	19	19	25	Form E	–	–

The accessories shown here must be used for all sizes!	Accessories	KMR-25		Coolant supply tube for HSK tooling		> Page 162
		WRENCHSK25		Wrench for coolant tubes		> Page 162

HSK 25 form E

HSC precision collet chucks ER 16



Characteristics:



HSC precision collet chucks ER 16	Order no.	d_1	l_3	A	d_3	d_4	d_2	DIN / shape	l_2	l_1
-----------------------------------	-----------	-------	-------	---	-------	-------	-------	-------------	-------	-------

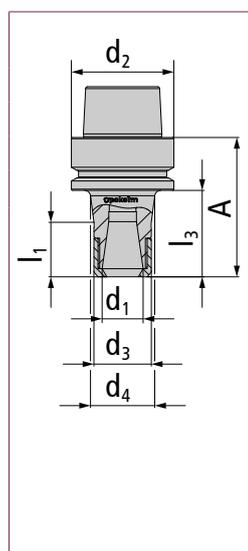

ER 16	40 ER16 E25	16	40	50	22	20	25	Form E	–	10.5
Accessories	4ER16 001	Tightning nut ER 16							> Page 161	
	16 501	Collet chuck wrench for ER 16 tightening nut							> Page 161	
	KMR-25	Coolant supply tube for HSK tooling							> Page 162	
	WRENCHSK25	Wrench for coolant tubes							> Page 162	

HSK 32 form E

for shrinking



Characteristics:   **HSC** **Form E** **DIN 69893** **G 2,5 30.000**

for shrinking	Order no.	d_1	l_3	A	d_3	d_4	d_2	DIN / shape	l_2	l_1
---------------	-----------	-------	-------	---	-------	-------	-------	-------------	-------	-------

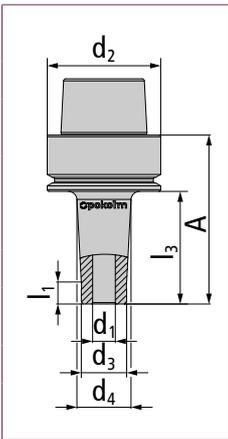

Diameter 3 mm	40 03 E32 S.01	3	40	60	9	12.4	32	Form E	–	7.8
Diameter 4 mm	40 04 E32 S.01	4	40	60	10.5	13.87	32	Form E	–	7.8
Diameter 6 mm	40 06 E32 S	6	40	60	12	15.4	32	Form E	–	7.8
Diameter 8 mm	40 08 E32 S	8	40	60	16	20	32	Form E	–	7.8
Diameter 10 mm	40 10 E32 S	10	40	60	20	24	32	Form E	–	7.8

The accessories shown here must be used for all sizes!	Accessories	KMR-32	Coolant supply tube for HSK tooling	> Page 162
		WRENCHHSK32	Wrench for coolant tubes	> Page 162

HSK 32 form E

HSC precision collet chucks ER 20



Characteristics:   **HSC** **Form E** **DIN 69893** **G 2,5 30.000**

HSC precision collet chucks ER 20	Order no.	d ₁	l ₃	A	d ₃	d ₄	d ₂	DIN / shape	l ₂	l ₁
-----------------------------------	-----------	----------------	----------------	---	----------------	----------------	----------------	-------------	----------------	----------------

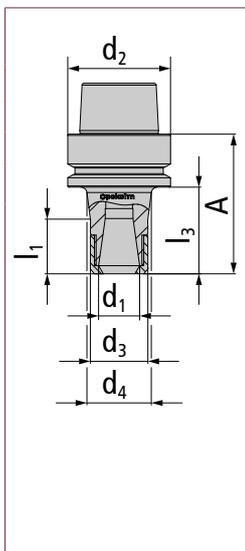

ER 20	40 ER20 E32	20	40	60	28	28	32	Form E	–	11.8
Accessories	ER20 001	Tightning nut							> Page 161	
	20 501	Collet chuck wrench for ER 20 tightening nut							> Page 161	
	KMR-32	Coolant supply tube for HSK tooling							> Page 162	
	WRENCHSK32	Wrench for coolant tubes							> Page 162	

HSK 40 form E

for threaded shank end mills

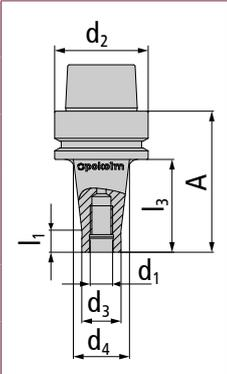

Characteristics:   **HSC** **Form E** **DIN 69893** **G 2,5 30.000**

for threaded shank end mills	Order no.	d_1	l_3	A	d_3	d_4	d_2	DIN / shape	l_2	l_1	
	M 8	25 08 E40	8	25	45	13.8	15	40	Form E	–	12
		50 08 E40	8	50	70	13.8	23	40	Form E	–	12
		75 08 E40	8	75	95	13.8	25	40	Form E	–	12
	M 10	25 10 E40	10	25	45	18	23	40	Form E	–	12
		50 10 E40	10	50	70	18	25	40	Form E	–	12
		75 10 E40	10	75	95	18	30	40	Form E	–	12
The accessories shown here must be used for all sizes!	Accessories	KMR-40A	Coolant supply tube for HSK tooling					> Page 162			
		WRENCHSK40	Wrench for coolant tubes					> Page 162			

HSK 40 form E

for shrinking

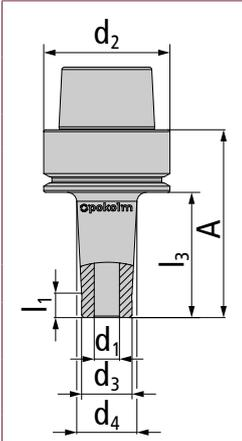

Characteristics:   **HSC**  **Form E**  **DIN 69893**  **G 2,5 30.000**

for shrinking	Order no.	d ₁	l ₃	A	d ₃	d ₄	d ₂	DIN / shape	l ₂	l ₁	
	Diameter 3 mm	40 03 E40 S.01	3	40	60	9	14	40	Form E	–	7.8
		70 03 E40 S.01	3	70	90	9	18.79	40	Form E	–	7.8
	Diameter 4 mm	40 04 E40 S.01	4	40	60	10.5	13.9	40	Form E	–	7.8
		70 04 E40 S.01	4	70	90	10.5	17.02	40	Form E	–	7.8
	Diameter 6 mm	40 06 E40 S	6	40	60	12	15.4	40	Form E	–	7.8
		70 06 E40 S	6	70	90	12	18.5	40	Form E	–	7.8
	Diameter 8 mm	40 08 E40 S	8	40	60	16	19	40	Form E	–	7.8
		70 08 E40 S	8	70	90	16	23	40	Form E	–	7.8
	Diameter 10 mm	40 10 E40 S	10	40	60	20	23.4	40	Form E	–	7.8
		70 10 E40 S	10	70	90	20	26.5	40	Form E	–	7.8
	Diameter 12 mm	40 12 E40 S	12	40	60	24	27.4	40	Form E	–	7.8
		70 12 E40 S	12	70	90	24	30.5	40	Form E	–	7.8
	Diameter 16 mm	40 16 E40 S	16	40	60	32	32	40	Form E	–	–

The accessories shown here must be used for all sizes!	Accessories	KMR-40A	Coolant supply tube for HSK tooling	> Page 162
		WRENCHHSK40	Wrench for coolant tubes	> Page 162

HSK 40 form E

Drill chucks



Characteristics:   **Form E** **DIN 69893** **G 6,3 25.000**

Drill chucks	Order no.	d_1	l_3	A	d_3	d_4	d_2	DIN / shape	l_2	l_1
--------------	-----------	-------	-------	---	-------	-------	-------	-------------	-------	-------

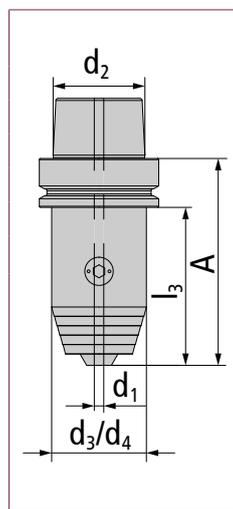

Diam. 0.3 to 8 mm	BF 0.3-8 E40 IC	8	74	94	36	36	40	Form E	–	–
Accessories	HEXA 4T	HEXA 4T							> Page 161	
	KMR-40A	Coolant supply tube for HSK tooling							> Page 162	
	WRENCHHSK40	Wrench for coolant tubes							> Page 162	
	BF08DS04	Gasket 0804							> Page 163	
	BF08DS08	Gasket 0808							> Page 163	
	BF08MW	Wrench 08							> Page 163	

Scope of delivery includes wrench and gasket

HSK 40 form E

HSC precision collet chucks ER 20



Characteristics:







HSC precision collet chucks ER 20	Order no.	d ₁	l ₃	A	d ₃	d ₄	d ₂	DIN / shape	l ₂	l ₁
-----------------------------------	-----------	----------------	----------------	---	----------------	----------------	----------------	-------------	----------------	----------------

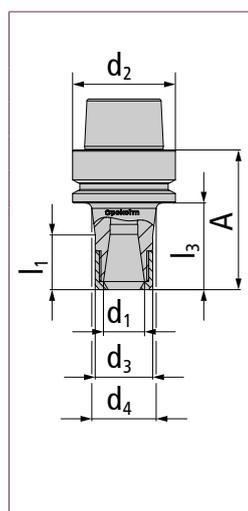

ER 20	50 ER20 E40	20	50	70	28	32	40	Form E	–	34.3	
Accessories	ER20 001	Tightning nut							> Page 161		
	20 501	Collet chuck wrench for ER 20 tightening nut							> Page 161		
	KMR-40A	Coolant supply tube for HSK tooling							> Page 162		
	WRENCHSK40	Wrench for coolant tubes							> Page 162		

Scope of delivery includes a tightening nut, which is approved up to n = 80,000 1/min

HSK 40 form EC

for shrinking

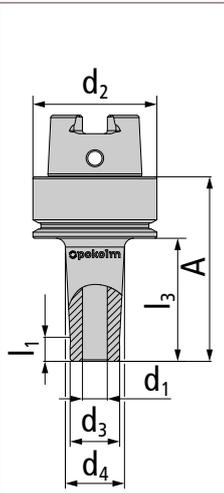

Characteristics:      

for shrinking	Order no.	d ₁	l ₃	A	d ₃	d ₄	d ₂	DIN / shape	l ₂	l ₁	
	Diameter 3 mm	40 03 EC 40 S.01	3	40	60	9	14	40	Form E+C	–	7.8
	70 03 EC 40 S.01	3	70	90	9	18.79	40	Form E+C	–	7.8	
	Diameter 4 mm	40 04 EC 40 S.01	4	40	60	10.5	13.87	40	Form E+C	–	7.8
	70 04 EC 40 S.01	4	70	90	10.5	17	40	Form E+C	–	7.8	
	Diameter 6 mm	40 06 EC 40 S	6	40	60	12	15.4	40	Form E+C	–	7.8
	70 06 EC 40 S	6	70	90	12	19	40	Form E+C	–	7.8	
	100 06 EC 40 S	6	100	120	12	22	40	Form E+C	–	7.8	
	Diameter 8 mm	40 08 EC 40 S	8	40	60	16	19.4	40	Form E+C	–	7.8
	70 08 EC 40 S	8	70	90	16	22.5	40	Form E+C	–	7.8	
	100 08 EC 40 S	8	100	120	16	26	40	Form E+C	–	7.8	
	Diameter 10 mm	40 10 EC 40 S	10	40	60	20	24	40	Form E+C	–	7.8
	70 10 EC 40 S	10	70	90	20	26.5	40	Form E+C	–	7.8	
	100 10 EC 40 S	10	100	120	20	29.6	40	Form E+C	–	7.8	
	Diameter 12 mm	40 12 EC 40 S	12	40	60	24	28	40	Form E+C	–	7.8
	70 12 EC 40 S	12	70	90	24	30.5	40	Form E+C	–	7.8	
	Diameter 16 mm	40 16 EC 40 S	16	40	60	32	32	40	Form E+C	–	–

The accessories shown here must be used for all sizes!	Accessories	KMR-40A	Coolant supply tube for HSK tooling	> Page 162
		WRENCHHSK40	Wrench for coolant tubes	> Page 162

HSK 50 form E

for threaded shank end mills

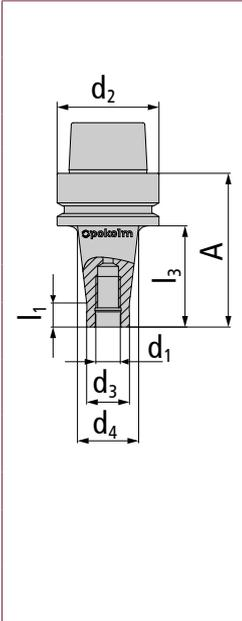

Characteristics:   **HSC**  **Form E**  **DIN 69893**  **G 2,5 30.000**

for threaded shank end mills	Order no.	d ₁	l ₃	A	d ₃	d ₄	d ₂	DIN / shape	l ₂	l ₁	
	M 8	25 08 E50	8	25	51	13.8	15	50	Form E	–	12
		50 08 E50	8	50	76	13.8	23	50	Form E	–	12
	M 10	25 10 E50	10	25	51	18	23	50	Form E	–	12
		50 10 E50	10	50	76	18	25	50	Form E	–	12
	M 12	25 12 E50	12	25	51	21	24	50	Form E	–	12
		50 12 E50	12	50	76	21	30	50	Form E	–	12
		100 12 E50	12	100	126	21	38	50	Form E	–	12
	M 16	25 16 E50	16	25	51	29	29	50	Form E	–	–
		50 16 E50	16	50	76	29	34	50	Form E	–	12
	The accessories shown here must be used for all sizes!	Accessories	KMR-50A	Coolant supply tube for HSK tooling				> Page 162			
			WRENCHSK50	Wrench for coolant tubes				> Page 162			

HSK 50 form E

for shrinking



Characteristics:

-
-
- HSC**
- Form E
- DIN 69893
- G 2,5
30.000

for shrinking	Order no.	d ₁	l ₃	A	d ₃	d ₄	d ₂	DIN / shape	l ₂	l ₁
---------------	-----------	----------------	----------------	---	----------------	----------------	----------------	-------------	----------------	----------------

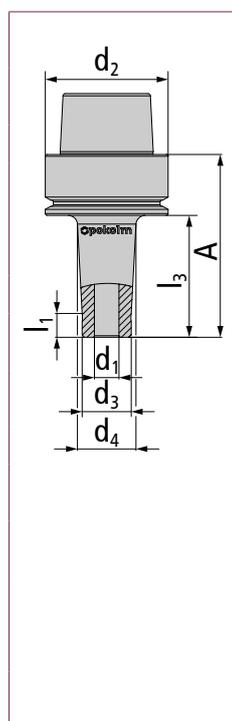

Diameter 3 mm	50 03 E50 S.01	3	50	76	9	15.6	50	Form E	–	7.8
	100 03 E50 S.01	3	100	126	9	23.5	50	Form E	–	7.8
Diameter 4 mm	50 04 E50 S.01	4	50	76	10.5	14.9	50	Form E	–	7.8
	100 04 E50 S.01	4	100	126	10.5	20.2	50	Form E	–	7.8
Diameter 6 mm	50 06 E50 S	6	50	76	12	16.4	50	Form E	–	7.8
	100 06 E50 S	6	100	126	12	21.6	50	Form E	–	7.8
Diameter 8 mm	50 08 E50 S	8	50	76	16	20.3	50	Form E	–	7.8
	100 08 E50 S	8	100	126	16	25.7	50	Form E	–	7.8
Diameter 10 mm	50 10 E50 S	10	50	76	20	24.4	50	Form E	–	7.8
	100 10 E50 S	10	100	126	20	30	50	Form E	–	7.8

The accessories shown here must be used for all sizes!	Accessories	KMR-50A	Coolant supply tube for HSK tooling	> Page 162
		WRENCHHSK50	Wrench for coolant tubes	> Page 162

Characteristics:







on Shrink-fitting	Order no.	d_1	l_3	A	d_3	d_4	d_2	DIN / shape	l_2	l_1
-------------------	-----------	-------	-------	---	-------	-------	-------	-------------	-------	-------

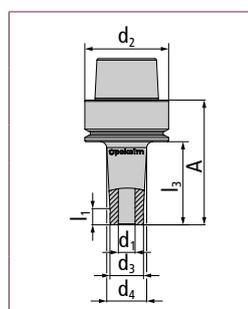

Diameter 12 mm	50 12 E50 S	12	50	76	24	28.4	50	Form E	–	7.8
	100 12 E50 S	12	100	126	24	34	50	Form E	–	7.8
Diameter 16 mm	50 16 E50 S	16	50	76	32	36.4	50	Form E	–	7.8
									–	
Diameter 20 mm	60 20 E50 S	20	60	86	40	40	50	Form E	–	–

The accessories shown here must be used for all sizes!	Accessories	KMR-50A	Coolant supply tube for HSK tooling	> Page 162
		WRENCHHSK50	Wrench for coolant tubes	> Page 162

<2/2

HSK 50 form E

Drill chucks



Characteristics:

-
-
- Form E**
-
- G 6,3 25.000**

Drill chucks	Order no.	d ₁	l ₃	A	d ₃	d ₄	d ₂	DIN / shape	l ₂	l ₁	
	Diam. 0.3 to 8 mm	BF 0.3-8 E50 IC	8	72	98	36	36	50	Form E	–	–
	Accessories	HEXA 4T	HEXA 4T		> Page 161						
		BF08DS04	Gasket 0804		> Page 163						
		BF08DS08	Gasket 0808		> Page 163						
		BF08MW	Wrench 08		> Page 163						
Diam. 0.5 to 13 mm	BF 0.5-13 E50 IC	13	96	122	50	50	50	Form E	–	–	
Accessories	HEXA 6T	HEXA 6T		> Page 161							
	BF13DS06	Gasket 1306		> Page 163							
	BF13DS13	Gasket 1313		> Page 163							
	BF13MW	Wrench 13/16		> Page 163							
Diam. 2.5 to 16 mm	BF 2.5-16 E50 IC	16	101	127	57	57	50	Form E	–	–	
Accessories	HEXA 6T	HEXA 6T		> Page 161							
	BF16DS06	Gasket 1606		> Page 163							
	BF16DS16	Gasket 1616		> Page 163							
	BF13MW	Wrench 13/16		> Page 163							
The accessories shown here must be used for all sizes!	Accessories	KMR-50A	Coolant supply tube for HSK tooling		> Page 162						
		WRENCHHSK50	Wrench for coolant tubes		> Page 162						

The scope of delivery includes a hex key and gasket

HSK 50 form E

HSC precision collet chucks ER 20



Characteristics:







HSC precision collet chucks ER 20	Order no.	d ₁	l ₃	A	d ₃	d ₄	d ₂	DIN / shape	l ₂	l ₁
-----------------------------------	-----------	----------------	----------------	---	----------------	----------------	----------------	-------------	----------------	----------------

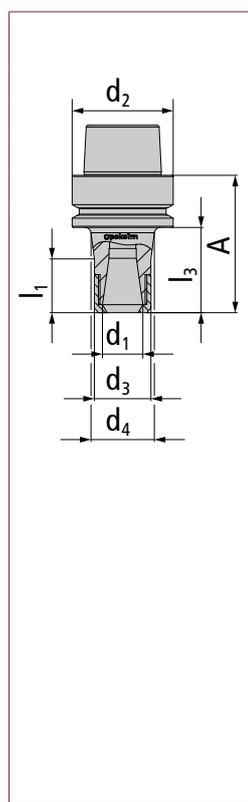

ER 20	50 ER20 E50	20	50	76	28	32	50	Form E	–	34.3	
Accessories	ER20 001	Tightning nut							> Page 161		
	20 501	Collet chuck wrench for ER 20 tightening nut							> Page 161		
	KMR-50A	Coolant supply tube for HSK tooling							> Page 162		
	WRENCHSK50	Wrench for coolant tubes							> Page 162		

Scope of delivery includes a tightening nut, which is approved up to n = 80,000 1/min

HSK 50 form E

for shrink gripping | CoolCap®

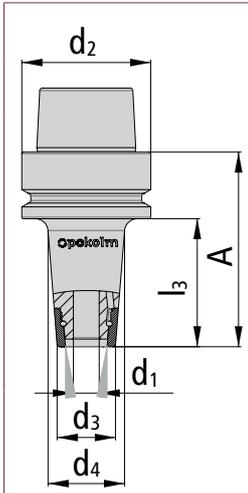
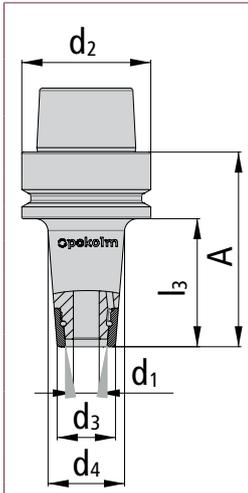
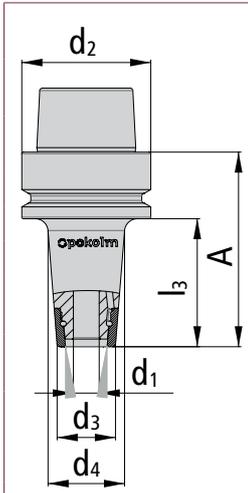

Characteristics:       

for shrink gripping CoolCap®	Order no.	d ₁	l ₃	A	d ₃	d ₄	d ₂	DIN / shape	l ₂	l ₁		
	Diameter 4 mm	50 04 E50 SR1	4	50	76	15	23.4	50	Form E	–	–	
		75 04 E50 SR1	4	75	101	15	27.3	50	Form E	–	–	
		100 04 E50 SR1	4	100	126	15	31.3	50	Form E	–	–	
	Accessories	SR1 S06 SW17	CoolCap® screw-on cap diam. 6							> Page 162		
		SR1 A04 SW17	CoolCap® screw-on cap diam. 4							> Page 163		
		Diameter 6 mm	50 06 E50 SR1	6	50	76	16.5	24.4	50	Form E	–	–
			75 06 E50 SR1	6	75	101	16.5	28.33	50	Form E	–	–
			100 06 E50 SR1	6	100	126	16.5	32.27	50	Form E	–	–
		Accessories	SR1 S06 SW17	CoolCap® screw-on cap diam. 6							> Page 162	
			SR1 A06 SW17	CoolCap® screw-on cap diam. 6							> Page 163	
		Diameter 8 mm	50 08 E50 SR1	8	50	76	20.5	28.4	50	Form E	–	–
			75 08 E50 SR1	8	75	101	20.5	32.33	50	Form E	–	–
			100 08 E50 SR1	8	100	126	20.5	36.27	50	Form E	–	–
		Accessories	SR1 S08 SW21	CoolCap® screw-on cap diam. 8							> Page 162	
			SR1 A08 SW21	CoolCap® screw-on cap diam. 8							> Page 163	
	The accessories shown here must be used for all sizes!	Accessories	KMR-50A	Coolant supply tube for HSK tooling							> Page 162	
			WRENCHHSK50	Wrench for coolant tubes							> Page 162	
			SR1 ZSW 002	CoolCap® application tool							> Page 163	
			DMS 3/8 8-60 NM	Torque wrench 3/8"							> Page 163	

The scope of delivery for each CoolCap® cooling arbor includes one cap. In your order, please indicate whether you would like a cap for air/MMS or a cap for emulsion/coolant. Other caps can be ordered separately. Only tighten and loosen caps using the application tool or ring wrench!

Characteristics:

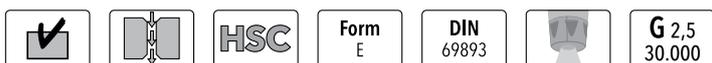

for shrink gripping CoolCap®		Order no.	d ₁	l ₃	A	d ₃	d ₄	d ₂	DIN / shape	l ₂	l ₁	
	Diameter 10 mm	50 10 E50 SR1	10	50	76	22.5	30.4	50	Form E	–	–	
		75 10 E50 SR1	10	75	101	22.5	34.3	50	Form E	–	–	
		100 10 E50 SR1	10	100	126	22.5	38.3	50	Form E	–	–	
	Accessories	SR1 S10 SW22	CoolCap® screw-on cap diam. 10						> Page 162			
	SR1 A10 SW22	CoolCap® screw-on cap diam. 10						> Page 163				
	Diameter 12 mm	50 12 E50 SR1	12	50	76	26.5	34.4	50	Form A	–	–	
		75 12 E50 SR1	12	75	101	26.5	38.33	50	Form A	–	–	
		100 12 E50 SR1	12	100	126	26.5	40	50	Form A	–	–	
	Accessories	SR1 S12 SW27	CoolCap® screw-on cap diam. 12						> Page 162			
	SR1 A12 SW2	CoolCap® screw-on cap diam. 12						> Page 163				
<p>The accessories shown here must be used for all sizes!</p>	Accessories	KMR-50A	Coolant supply tube for HSK tooling						> Page 162			
		WRENCHHSK50	Wrench for coolant tubes						> Page 162			
		SR1 ZSW 002	CoolCap® application tool						> Page 163			
		DMS 3/8 8-60 NM	Torque wrench 3/8"						> Page 163			

<2/2

HSK 63 form A

for threaded shank end mills



Characteristics:   **HSC** **Form A** **DIN 69893** **G 2,5 25.000**

for threaded shank end mills	Order no.	d ₁	l ₃	A	d ₃	d ₄	d ₂	DIN / shape	l ₂	l ₁
------------------------------	-----------	----------------	----------------	---	----------------	----------------	----------------	-------------	----------------	----------------

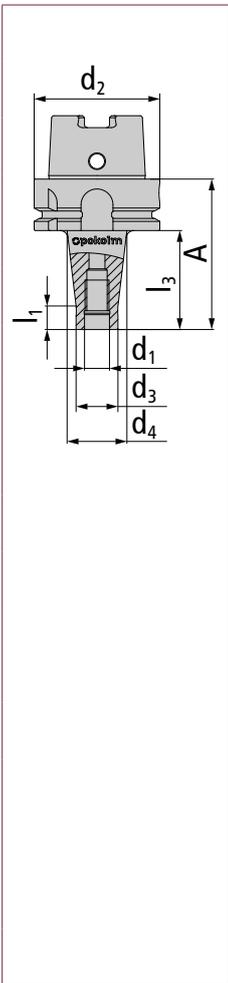

M 8	25 08 A63	8	25	51	13.8	15	63	Form A	-	12
	50 08 A63	8	50	76	13.8	23	63	Form A	-	12
	75 08 A63	8	75	101	13.8	25	63	Form A	-	12
	100 08 A63	8	100	126	13.8	30	63	Form A	-	12
M 10	25 10 A63	10	25	51	18	23	63	Form A	-	12
	50 10 A63	10	50	76	18	25	63	Form A	-	12
	75 10 A63	10	75	101	18	30	63	Form A	-	12
	100 10 A63	10	100	126	18	35	63	Form A	-	12
	125 10 A63	10	125	151	18	38	63	Form A	-	12
	150 10 A63	10	150	176	18	45	63	Form A	-	12
M 12	25 12 A63	12	25	51	21	24	63	Form A	-	12
	50 12 A63	12	50	76	21	30	63	Form A	-	12
	75 12 A63	12	75	101	21	35	63	Form A	-	12
	100 12 A63	12	100	126	21	38	63	Form A	-	12
	125 12 A63	12	125	151	21	43	63	Form A	-	12
	150 12 A63	12	150	176	21	45	63	Form A	-	12

The accessories shown here must be used for all sizes!	Accessories	KMR-63A	Coolant tubes	> Page 162
		WRENCHHSK63	Wrench for coolant tubes	> Page 162

Characteristics:   **HSC**  **Form A**  **DIN 69893**  **G 2,5 25.000**

for threaded shank end mills	Order no.	d ₁	l ₃	A	d ₃	d ₄	d ₂	DIN / shape	l ₂	l ₁
------------------------------	-----------	----------------	----------------	---	----------------	----------------	----------------	-------------	----------------	----------------

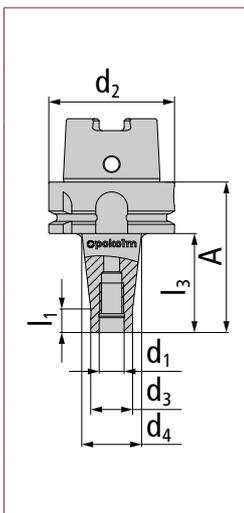

M 16	25 16 A63	16	25	51	29	29	63	Form A	–	–
	50 16 A63	16	50	76	29	34	63	Form A	–	12
	75 16 A63	16	75	101	29	35	63	Form A	–	12
	100 16 A63	16	100	126	29	40	63	Form A	–	12
	125 16 A63	16	125	151	29	44	63	Form A	–	12
	150 16 A63	16	150	176	29	48	63	Form A	–	12
	175 16 A63	16	175	201	29	50	63	Form A	–	12
	200 16 A63	16	200	226	29	50	63	Form A	–	12
	250 16 A63	16	250	276	29	50	63	Form A	–	12

The accessories shown here must be used for all sizes!	Accessories	KMR-63A	Coolant tubes	> Page 162
		WRENCHHSK63	Wrench for coolant tubes	> Page 162

<2/2

HSK 63 form A

for threaded shank milling | cylindrical



Characteristics:   **HSC** **Form A** **DIN 69893** **G 2,5 25.000**

for threaded shank milling cylindrical	Order no.	d_1	l_3	A	d_3	d_4	d_2	DIN / shape	l_2	l_1
--	-----------	-------	-------	---	-------	-------	-------	-------------	-------	-------

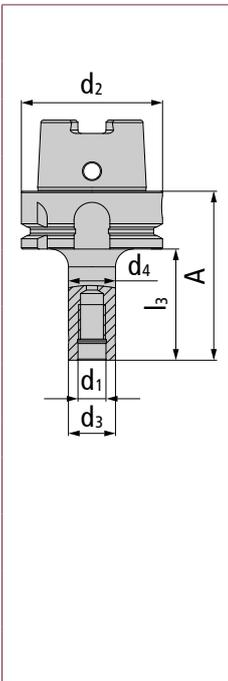

M 8	50 08 A63 ZYL	8	50	76	13.8	13.8	63	Form A	-	-	
	M 10	50 10 A63 ZYL	10	50	76	18	18	63	Form A	-	-
		75 10 A63 ZYL	10	75	101	18	18	63	Form A	-	-
	M 12	50 12 A63 ZYL	12	75	101	21	21	63	Form A	-	-
75 12 A63 ZYL		12	50	76	21	21	63	Form A	-	-	
100 12 A63 ZYL		12	100	126	21	21	63	Form A	-	-	
M 16	50 16 A63 ZYL	16	50	76	29	29	63	Form A	-	-	
	75 16 A63 ZYL	16	75	101	29	29	63	Form A	-	-	
	100 16 A63 ZYL	16	100	126	29	29	63	Form A	-	-	
	125 16 A63 ZYL	16	125	151	29	29	63	Form A	-	-	

The accessories shown here must be used for all sizes!	Accessories	KMR-63A	Coolant supply tube for HSK tooling	> Page 162
		WRENCHHSK63	Wrench for coolant tubes	> Page 162

HSK 63 form A

for shrinking



Characteristics:







for shrinking	Order no.	d ₁	l ₃	A	d ₃	d ₄	d ₂	DIN / shape	l ₂	l ₁
---------------	-----------	----------------	----------------	---	----------------	----------------	----------------	-------------	----------------	----------------

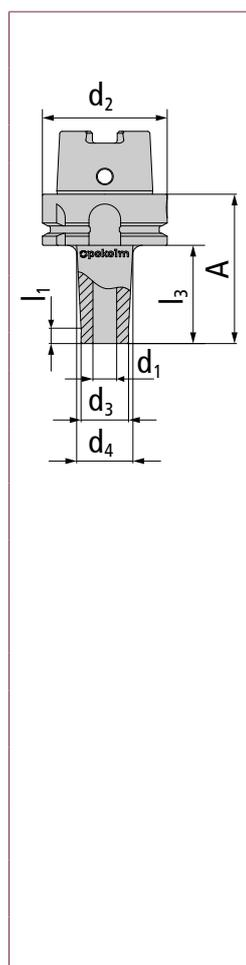

Diameter 3 mm	50 03 A63 S.01	3	50	76	9	15.6	63	Form A	–	7.8
	100 03 A63 S.01	3	100	126	9	23.5	63	Form A	–	7.8
Diameter 4 mm	50 04 A63 S.01	4	50	76	10.5	14.9	63	Form A	–	7.8
	75 04 A63 S.01	4	75	101	10.5	17.6	63	Form A	–	7.8
	100 04 A63 S.01	4	100	126	10.5	20.2	63	Form A	–	7.8
Diameter 6 mm	50 06 A63 S	6	50	76	12	16.4	63	Form A	–	7.8
	75 06 A63 S	6	75	101	12	19	63	Form A	–	7.8
	100 06 A63 S	6	100	126	12	21.7	63	Form A	–	7.8
	150 06 A63 S	6	150	176	12	27	63	Form A	–	7.8
	200 06 A63 S	6	200	226	12	32.1	63	Form A	–	7.8
Diameter 8 mm	50 08 A63 S	8	50	76	16	20.4	63	Form A	–	7.8
	75 08 A63 S	8	75	101	16	23	63	Form A	–	7.8
	100 08 A63 S	8	100	126	16	25.7	63	Form A	–	7.8
	150 08 A63 S	8	150	176	16	30.9	63	Form A	–	7.8
	200 08 A63 S	8	200	226	16	36.1	63	Form A	–	7.8

The accessories shown here must be used for all sizes!	Accessories	KMR-63A	Coolant supply tube for HSK tooling	> Page 162
		WRENCHHSK63	Wrench for coolant tubes	> Page 162

HSK 63 form A

for shrinking



Characteristics:

-
-
- HSC**
- Form A**
- DIN 69893**
- G 2,5 25.000**

for shrinking	Order no.	d ₁	l ₃	A	d ₃	d ₄	d ₂	DIN / shape	l ₂	l ₁
---------------	-----------	----------------	----------------	---	----------------	----------------	----------------	-------------	----------------	----------------

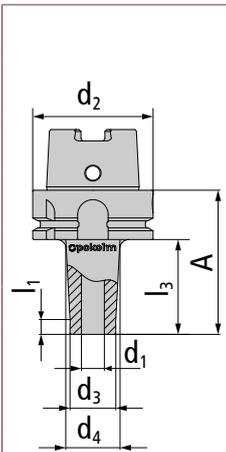

Diameter 10 mm	50 10 A63 S	10	50	76	20	24.4	63	Form A	–	7.8
	75 10 A63 S	10	75	101	20	27	63	Form A	–	7.8
	100 10 A63 S	10	100	126	20	30	63	Form A	–	7.8
	150 10 A63 S	10	150	176	20	35	63	Form A	–	7.8
	200 10 A63 S	10	200	226	20	40.1	63	Form A	–	7.8

Diameter 12 mm	50 12 A63 S	12	50	76	24	28.4	63	Form A	–	7.8
	75 12 A63 S	12	75	101	24	31	63	Form A	–	7.8
	100 12 A63 S	12	100	126	24	33.7	63	Form A	–	7.8
	150 12 A63 S	12	150	176	24	39	63	Form A	–	7.8
	200 12 A63 S	12	200	226	24	44.1	63	Form A	–	7.8

Diameter 16 mm	50 16 A63 S	16	50	76	32	36.4	63	Form A	–	7.8
	75 16 A63 S	16	75	101	32	39	63	Form A	–	7.8
	100 16 A63 S	16	100	126	32	41.7	63	Form A	–	7.8
	150 16 A63 S	16	150	176	32	46.9	63	Form A	–	7.8

The accessories shown here must be used for all sizes!	Accessories	KMR-63A	Coolant supply tube for HSK tooling	> Page 162
		WRENCHHSK63	Wrench for coolant tubes	> Page 162

Characteristics:







for shrinking	Order no.	d ₁	l ₃	A	d ₃	d ₄	d ₂	DIN / shape	l ₂	l ₁
---------------	-----------	----------------	----------------	---	----------------	----------------	----------------	-------------	----------------	----------------

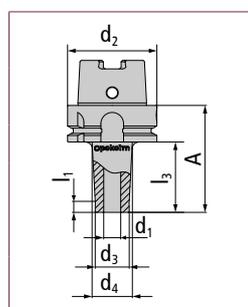

Diameter 20 mm	60 20 A63 S	20	60	86	40	45.5	63	Form A	–	7.8
	100 20 A63 S	20	100	126	40	49.7	63	Form A	–	7.8
Diameter 25 mm	60 25 A63 S	25	60	86	46	46	63	Form A	–	–
Diameter 32 mm	60 32 A63 S	32	60	86	44	52	63	Form A	–	–

The accessories shown here must be used for all sizes!	Accessories	KMR-63A	Coolant supply tube for HSK tooling	> Page 162
		WRENCHHSK63	Wrench for coolant tubes	> Page 162

<3/3

HSK 63 form A

for shrinking | reinforced design



Characteristics:

-
-
- HSC**
- Form A**
- DIN 69893**
- G 2,5 25.000**
-

for shrinking reinforced design	Order no.	d_1	l_3	A	d_3	d_4	d_2	DIN / shape	l_2	l_1
-----------------------------------	-----------	-------	-------	---	-------	-------	-------	-------------	-------	-------

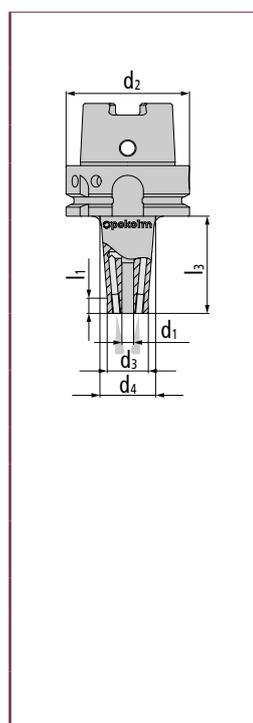

Diameter 6 mm	50 06 A63 SB	6	50	76	21	27.6	63	Form A	–	7.8
	100 06 A63 SB	6	100	126	21	35.5	63	Form A	–	7.8
Diameter 8 mm	50 08 A63 SB	8	50	76	21	27.6	63	Form A	–	7.8
	100 08 A63 SB	8	100	126	21	35.5	63	Form A	–	7.8
Diameter 10 mm	50 10 A63 SB	10	50	76	24	30.6	63	Form A	–	7.8
	100 10 A63 SB	10	100	126	24	38.5	63	Form A	–	7.8
Diameter 12 mm	50 12 A63 SB	12	50	76	24	30.6	63	Form A	–	7.8
	100 12 A63 SB	12	100	126	24	38.5	63	Form A	–	7.8
Diameter 16 mm	50 16 A63 SB	16	50	76	32	38.6	63	Form A	–	7.8
	100 16 A63 SB	16	100	126	32	46.5	63	Form A	–	7.8

The accessories shown here must be used for all sizes!	Accessories	KMR-63A	Coolant tubes	> Page 162
		WRENCHHSK63	Wrench for coolant tubes	> Page 162

HSK 63 form A

for shrink gripping | CoolCap®



Characteristics:

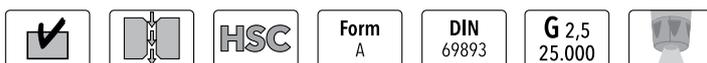

for shrink gripping CoolCap®	Order no.	d ₁	l ₃	A	d ₃	d ₄	d ₂	DIN / shape	l ₂	l ₁
--------------------------------	-----------	----------------	----------------	---	----------------	----------------	----------------	-------------	----------------	----------------

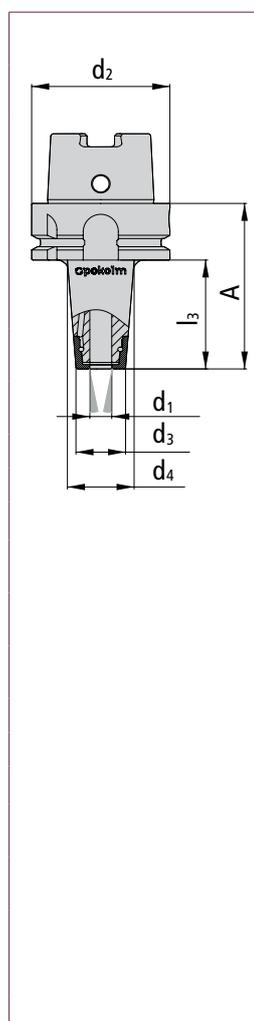

Diameter 4 mm	50 04 A63 SR1	4	50	76	15	22.9	63	Form A	–	–
	75 04 A63 SR1	4	75	101	15	26.8	63	Form A	–	–
	100 04 A63 SR1	4	100	126	15	30.8	63	Form A	–	–
Accessories	SR1 S06 SW17	CoolCap® screw-on cap diam. 6							> Page 162	
	SR1 A04 SW17	CoolCap® screw-on cap diam. 4							> Page 163	

Diameter 6 mm	50 06 A63 SR1	6	50	76	16.5	24.4	63	Form A	–	–
	75 06 A63 SR1	6	75	101	16.5	28.4	63	Form A	–	–
	100 06 A63 SR1	6	100	126	16.5	32.3	63	Form A	–	–
Accessories	SR1 S06 SW17	CoolCap® screw-on cap diam. 6							> Page 162	
	SR1 A06 SW17	CoolCap® screw-on cap diam. 6							> Page 163	

Diameter 8 mm	50 08 A63 SR1	8	50	76	20.5	27.4	63	Form A	–	–
	75 08 A63 SR1	8	75	101	20.5	32.4	63	Form A	–	–
	100 08 A63 SR1	8	100	126	20.5	36.3	63	Form A	–	–
Accessories	SR1 S08 SW21	CoolCap® screw-on cap diam. 8							> Page 162	
	SR1 A08 SW21	CoolCap® screw-on cap diam. 8							> Page 163	

Diameter 10 mm	50 10 A63 SR1	10	50	76	22.5	30.4	63	Form A	–	–
	75 10 A63 SR1	10	75	101	22.5	34.3	63	Form A	–	–
	100 10 A63 SR1	10	100	126	22.5	38.3	63	Form A	–	–
Accessories	SR1 S10 SW22	CoolCap® screw-on cap diam. 10							> Page 162	
	SR1 A10 SW22	CoolCap® screw-on cap diam. 10							> Page 163	

The accessories shown here must be used for all sizes!

Accessories	KMR-63A	Coolant tubes	> Page 162							
	WRENCHHSK63	Wrench for coolant tubes	> Page 162							
	SR1 ZSW 002	CoolCap® application tool	> Page 163							
	DMS 3/8 8-60 NM	Torque wrench 3/8"	> Page 163							

HSK 63 form A

for shrink gripping | CoolCap®

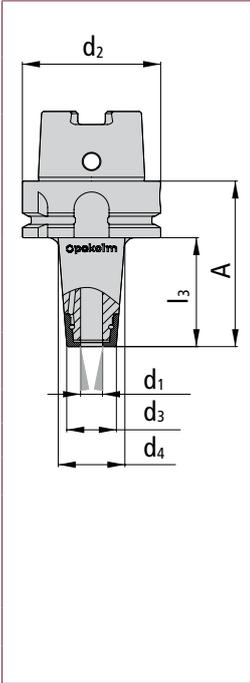

Characteristics:       

for shrink gripping CoolCap®	Order no.	d ₁	l ₃	A	d ₃	d ₄	d ₂	DIN / shape	l ₂	l ₁	
	Diameter 12 mm	60 12 A63 SR1	12	60	86	26.5	36	63	Form A	–	–
		75 12 A63 SR1	12	75	101	26.5	38.4	63	Form A	–	–
		100 12 A63 SR1	12	100	126	26.5	42.3	63	Form A	–	–
	Accessories	SR1 S12 SW27	CoolCap® screw-on cap diam. 12							> Page 162	
		SR1 A12 SW27	CoolCap® screw-on cap diam. 12							> Page 163	
	Diameter 16 mm	60 16 A63 SR1	16	60	86	31.5	41	63	Form A	–	–
		100 16 A63 SR1	16	100	126	31.5	47.3	63	Form A	–	–
		Accessories	SR1 S16 SW32	CoolCap® screw-on cap diam. 16							> Page 162
	SR1 A16 SW32		CoolCap® screw-on cap diam. 16							> Page 162	
	Diameter 20 mm	60 20 A63 SR1	20	60	86	36	45	63	Form A	–	–
100 20 A63 SR1		20	100	126	36	51.3	63	Form A	–	–	
Accessories		SR1 S20 SW36	CoolCap® screw-on cap diam. 20							> Page 162	
	SR1 A20 SW36	CoolCap® screw-on cap diam. 20							> Page 163		
The accessories shown here must be used for all sizes!	Accessories	KMR-63A	Coolant tubes							> Page 162	
		WRENCHSK63	Wrench for coolant tubes							> Page 162	
		SR1 ZSW 002	CoolCap® application tool							> Page 163	
		DMS 3/8 8-60 NM	Torque wrench 3/8"							> Page 163	

The scope of delivery for each CoolCap® cooling arbor includes one cap. In your order, please indicate whether you would like a cap for air/MMS or a cap for emulsion/coolant. Other caps can be ordered separately. Only tighten and loosen caps using the application tool or ring wrench!

HSK 63 form A

for Weldon shank | CoolCap®

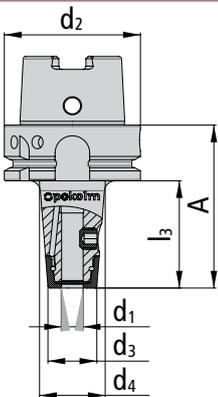

Characteristics:   **HSC**  **Form A**  **DIN 69893**  **G 2,5 25.000** 

for Weldon shank CoolCap®		Order no.	d ₁	l ₃	A	d ₃	d ₄	d ₂	DIN / shape	l ₂	l ₁
	Diameter 10 mm	50 10 A63 SR1 W	10	50	76	22.5	30.4	63	Form A	–	–
	Accessories	SR1 S10 SW22	CoolCap® screw-on cap diam. 10							> Page 162	
		SR1 A10 SW22	CoolCap® screw-on cap diam. 10							> Page 163	
		M10X9 SR1 W	Weldon diam. 10 straining screw							> Page 160	
Diameter 12 mm	60 12 A63 SR1 W	12	60	86	26.5	36	63	Form A	–	–	
Accessories	SR1 S12 SW27	CoolCap® screw-on cap diam. 12							> Page 162		
	SR1 A12 SW27	CoolCap® screw-on cap diam. 12							> Page 163		
	M12X10 SR1 W	Weldon diam. 10 straining screw							> Page 160		
Diameter 16 mm	60 16 A63 SR1 W	16	60	86	31.5	41	63	Form A	–	–	
Accessories	SR1 S16 SW32	CoolCap® screw-on cap diam. 16							> Page 162		
	SR1 A16 SW32	CoolCap® screw-on cap diam. 16							> Page 163		
	M14X11 SR1 W	Weldon diam. 16 straining screw							> Page 160		
Diameter 20 mm	60 20 A63 SR1 W	20	60	86	36	45	63	Form A	–	–	
Accessories	SR1 S20 SW36	CoolCap® screw-on cap diam. 20							> Page 162		
	SR1 A20 SW36	CoolCap® screw-on cap diam. 16							> Page 163		
	M16X10 SR1 W	Weldon diam. 20 straining screw							> Page 160		
The accessories shown here must be used for all sizes!	Accessories	KMR-63A	Coolant supply tube for HSK tooling							> Page 162	
		WRENCHHSK63	Wrench for coolant tubes							> Page 162	
		SR1 ZSW 002	CoolCap® application tool							> Page 163	
		DMS 3/8 8-60 NM	Torque wrench 3/8"							> Page 163	

The scope of delivery for each CoolCap® cooling arbor includes one cap. In your order, please indicate whether you would like a cap for air/MMS or a cap for emulsion/coolant. Other caps can be ordered separately. Only tighten and loosen caps using the application tool or ring wrench!

HSK 63 form A

for shell-type milling cutters

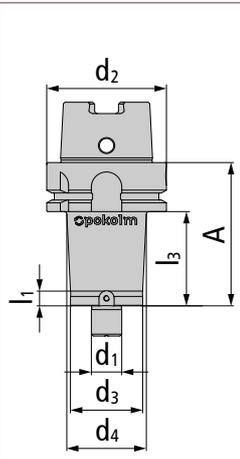

Characteristics:   **HSC** **Form A** **DIN 69893** **G 2,5 25.000**

for shell-type milling cutters	Order no.	d ₁	l ₃	A	d ₃	d ₄	d ₂	DIN / shape	l ₂	l ₁		
	Bore diam. 16 mm	25 16 A63 Z	16	25	51	38	40	63	Form A	–	7.8	
		50 16 A63 Z	16	50	76	38	42	63	Form A	–	7.8	
		75 16 A63 Z	16	75	101	38	45	63	Form A	–	7.8	
		100 16 A63 Z	16	100	126	38	50	63	Form A	–	7.8	
		125 16 A63 Z	16	125	151	38	50	63	Form A	–	7.8	
		150 16 A63 Z	16	150	176	38	50	63	Form A	–	7.8	
		200 16 A63 Z	16	200	226	38	50	63	Form A	–	7.8	
	Accessories	DRIVING8X8	Driving block 8 x 8							> Page 161		
		M3X10	Screw for driving block 8 x 8							> Page 160		
		M8X30	Screw M8x30							> Page 161		
	Bore diam. 22 mm	25 22 A63.01	22	25	51	48	48	63	Form A	–	–	
		50 22 A63.01	22	50	76	48	48	63	Form A	–	–	
		75 22 A63.01	22	75	101	48	50	63	Form A	–	7.8	
100 22 A63.01		22	100	126	48	50	63	Form A	–	7.8		
150 22 A63		22	150	176	48	48	63	Form A	–	7.8		
200 22 A63		22	200	226	48	49	63	Form A	–	7.8		
Accessories		DRIVING10X8	Driving block 10 x 8							> Page 161		
	M4X10	Screw for driving block 10 x 8							> Page 160			
	M10X35	Screw M10X35							> Page 161			
The accessories shown here must be used for all sizes!	Accessories	KMR-63A	Coolant supply tube for HSK tooling							> Page 162		
		WRENCHHSK63	Wrench for coolant tubes							> Page 162		
		4XGEBO-AUF	Threaded bores for adapter							> Page 160		

Characteristics:



for shell-type milling cutters	Order no.	d ₁	l ₃	A	d ₃	d ₄	d ₂	DIN / shape	l ₂	l ₁
--------------------------------	-----------	----------------	----------------	---	----------------	----------------	----------------	-------------	----------------	----------------

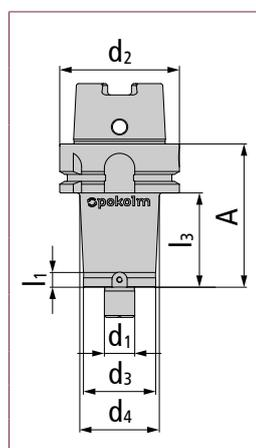

Bore diam. 27 mm	25 27 A63	27	25	51	48	48	63	Form A	–	–	
	50 27 A63	27	50	76	48	48	63	Form A	–	–	
	75 27 A63	27	75	101	48	48	63	Form A	–	–	
	100 27 A63	27	100	126	48	48	63	Form A	–	–	
	150 27 A63	27	150	176	48	48	63	Form A	–	–	
	200 27 A63	27	200	226	48	50	63	Form A	–	7.8	
Accessories	DRIVING12X8	Driving block 12 x 8							> Page 161		
	M5X12	Screw for driving block 12 x 8							> Page 160		
	M12X35	Screw M12X35							> Page 160		

The accessories shown here must be used for all sizes!

Accessories	KMR-63A	Coolant supply tube for HSK tooling							> Page 162		
	WRENCHHSK63	Wrench for coolant tubes							> Page 162		
	4XGEB0-AUF	Threaded bores for adapter							> Page 164		

Note: To use the Pokolm shell-type adapter, the base arbors must be fitted with 4 threaded bores! This must be included in the order, and is implemented by additionally ordering the bores under the item number: 4XGEB0-AUF

<2/2

HSK 63 form A

for shell-type milling cutters (vibration-dampened)

New



Characteristics:

-
-
- HSC**
- Form A**
- DIN 69893**
- G 6,3 8.000**
-

for shell-type milling cutters		Order no.	d_1	l_3	A	d_3	d_4	d_2	DIN / shape	l_2	l_1	
	Bore diam. 16 mm	A200 16 A63 VD	16	174	200	38	38	63	Form A	–	–	
		A300 16 A63 VD	16	274	300	38	38	63	Form A	–	–	
	Accessories	DRIVING8X8	Driving block 8 x 8								> Page 161	
		M3X10	Screw for driving block 8 x 8								> Page 160	
		M8X30	Screw M8x30								> Page 161	
	Bore diam. 22 mm	A200 22 A63 VD	22	174	200	48	48	63	Form A	–	–	
A300 22 A63 VD		22	274	300	48	48	63	Form A	–	–		
Accessories	DRIVING10X8	Driving block 10 x 8								> Page 161		
	M4X10	Screw for driving block 10 x 8								> Page 160		
	M10X35	Screw M10X35								> Page 161		
The accessories shown here must be used for all sizes!	Accessories	KMR-63A	Coolant supply tube for HSK tooling								> Page 162	
		WRENCHHSK63	Wrench for coolant tubes								> Page 162	

HSK 63 form A

Drill chucks

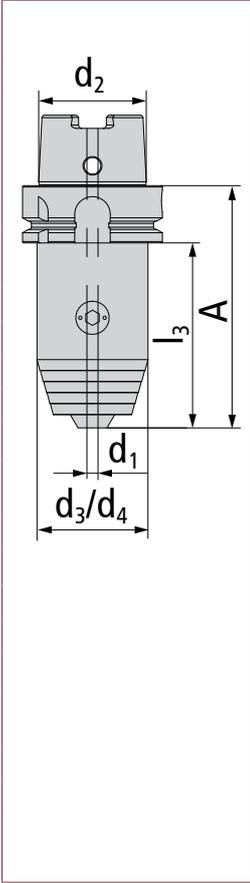

Characteristics:   **Form E** **DIN 69893**  **G 6,3 25.000**

Drill chucks	Order no.	d ₁	l ₃	A	d ₃	d ₄	d ₂	DIN / shape	l ₂	l ₁	
	Diam. 0.3 to 8 mm	BF 0.3-8 A63 IC	8	73	99	36	36	63	Form A	–	–
	Accessories	HEXA 4T	HEXA 4T	> Page 161							
		BF08DS04	Gasket 0804	> Page 163							
		BF08DS08	Gasket 0808	> Page 163							
		BF08MW	Wrench 08	> Page 163							
	Diam. 0.5 to 13 mm	BF 0.5-13 A63 IC	13	84	110	50	50	63	Form A	–	–
	Accessories	HEXA 6T	HEXA 6T	> Page 161							
		BF13DS06	Gasket 1306	> Page 163							
		BF13DS13	Gasket 1313	> Page 163							
		BF13MW	Wrench 13/16	> Page 163							
	Diam. 2.5 to 16 mm	BF 2.5-16 A63 IC	16	89	115	57	57	63	Form A	–	–
	Accessories	HEXA 6T	HEXA 6T	> Page 161							
		BF16DS06	Gasket 1606	> Page 163							
		BF16DS16	Gasket 1616	> Page 163							
		BF13MW	Wrench 13/16	> Page 163							
	Diam. 2.5 to 16 mm	A109 BF 2.5-16 A63	16	83	109	50	50	63	Form A	–	–
Accessories	HEXA 6T	Screw for driving block 10 x 8	> Page 161								
	BF16DS06	Gasket 1606	> Page 163								
	BF16DS16	Gasket 1616	> Page 163								
	BF13MW	Wrench 13/16	> Page 163								
The accessories shown here must be used for all sizes!	Accessories	KMR-63A	Coolant supply tube for HSK tooling		> Page 162						
		WRENCHHSK63	Wrench for coolant tubes		> Page 162						

Scope of delivery includes wrench and gasket

HSK 63 form A

for Morse tapers with tangs



Characteristics:   **Form A**  **G 2,5 25.000**

for Morse taper shanks	Order no.	d_1	l_3	A	d_3	d_4	d_2	DIN / shape	l_2	l_1
------------------------	-----------	-------	-------	---	-------	-------	-------	-------------	-------	-------

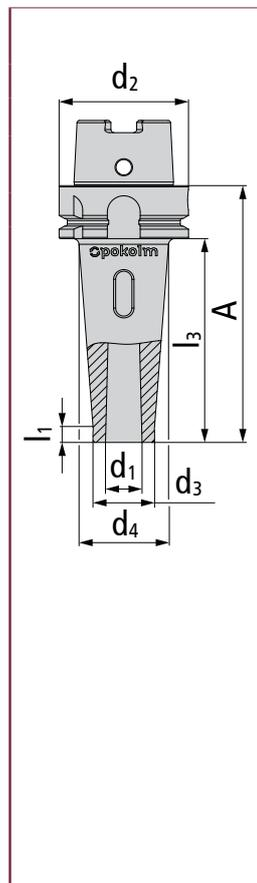

MK 2	100 MK2 AL A63	2	100	126	30	44	63	Form A	–	7.8	
Accessories	M10X45 IC	Screw for 100 MK2 AL A63						> Page 160			

MK 3	120 MK3 AL A63	3	120	146	35	46	63	Form A	–	7.8	
Accessories	M12X50 IC	Screw for 120 MK3 AL A63						> Page 160			

The accessories shown here must be used for all sizes!	Accessories	Z 00142	Spacer for arbors with tangs	> Page 161
		KMR-63A	Coolant supply tube for HSK tooling	> Page 162
		WRENCHSK63	Wrench for coolant tubes	> Page 162

HSK 63 form A

HSC precision collet chucks ER 20



Characteristics:







HSC precision collet chucks ER 20	Order no.	d ₁	l ₃	A	d ₃	d ₄	d ₂	DIN / shape	l ₂	l ₁
-----------------------------------	-----------	----------------	----------------	---	----------------	----------------	----------------	-------------	----------------	----------------

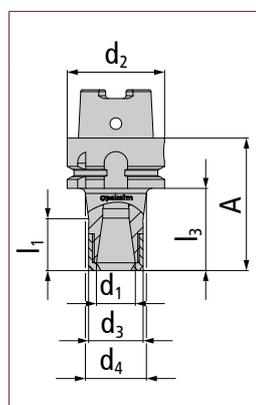

ER 20	50 ER20 A63	20	50	76	28	32	63	Form A	–	34.3	
	100 ER20 A63	20	100	126	28	40	63	Form A	–	34.3	
Accessories	ER20 001	Tightning nut							> Page 161		
	20 501	Collet chuck wrench for ER 20 tightening nut							> Page 161		
	KMR-63A	Coolant supply tube for HSK tooling							> Page 162		
	WRENCHSK6	Wrench for coolant tubes							> Page 162		

Scope of delivery includes a tightening nut, which is approved up to n = 80,000 1/min

HSK 100 form A

for threaded shank end mills



Characteristics:   **HSC** **Form A** **DIN 69893** **G 6,3 12.000**

for threaded shank end mills	Order no.	d ₁	l ₃	A	d ₃	d ₄	d ₂	DIN / shape	l ₂	l ₁
------------------------------	-----------	----------------	----------------	---	----------------	----------------	----------------	-------------	----------------	----------------

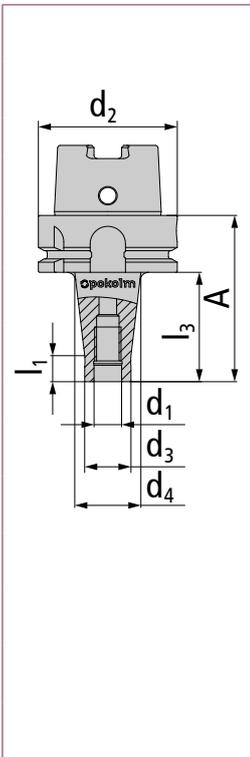

M 8	50 08 A100	8	50	79	13.8	23	100	Form A	–	12
	100 08 A100	8	100	129	13.8	30	100	Form A	–	12
M 10	50 10 A100	10	50	79	18	25	100	Form A	–	12
	75 10 A100	10	75	104	18	30	100	Form A	–	12
	100 10 A100	10	100	129	18	35	100	Form A	–	12
	150 10 A100	10	150	179	18	45	100	Form A	–	12
M 12	50 12 A100	12	50	79	21	30	100	Form A	–	12
	100 12 A100	12	100	129	21	38	100	Form A	–	12
	150 12 A100	12	150	179	21	52	100	Form A	–	12
	200 12 A100	12	200	229	21	58	100	Form A	–	12
	250 12 A100	12	250	279	21	62	100	Form A	–	12
	300 12 A100	12	300	329	21	68	100	Form A	–	12

The accessories shown here must be used for all sizes!	Accessories	KMR-100A	Coolant supply tube for HSK tooling	> Page 162
		WRENCHHSK100	Wrench for coolant tubes	> Page 162

Characteristics:



for threaded shank end mill body	Order no.	d ₁	l ₃	A	d ₃	d ₄	d ₂	DIN / shape	l ₂	l ₁
----------------------------------	-----------	----------------	----------------	---	----------------	----------------	----------------	-------------	----------------	----------------

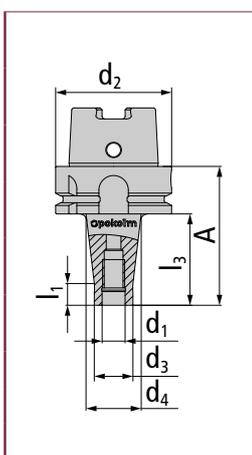

M 16	50 16 A100	16	50	79	29	34	100	Form A	–	12
	100 16 A100	16	100	129	29	40	100	Form A	–	12
	150 16 A100	16	150	179	29	58	100	Form A	–	12
	200 16 A100	16	200	229	29	58	100	Form A	–	12
	250 16 A100	16	250	279	29	66	100	Form A	–	12
	300 16 A100	16	300	329	29	66	100	Form A	–	12

Accessories	KMR-100A	Coolant supply tube for HSK tooling	> Page 162
	WRENCHHSK100	Wrench for coolant tubes	> Page 162

<2/2

HSK 100 form A

for shrinking

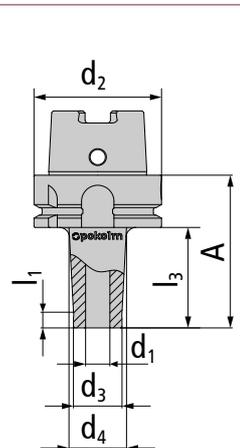

Characteristics:      

for shrinking	Order no.	d ₁	l ₃	A	d ₃	d ₄	d ₂	DIN / shape	l ₂	l ₁	
	Diameter 6 mm	100 06 A100 S	6	100	129	12	22	100	Form A	-	7.8
		150 06 A100 S	6	150	179	12	26.9	100	Form A	-	7.8
	Diameter 8 mm	100 08 A100 S	8	100	129	16	25.7	100	Form A	-	7.8
		150 08 A100 S	8	150	179	16	30.9	100	Form A	-	7.8
	Diameter 10 mm	100 10 A100 S	10	100	129	20	29.7	100	Form A	-	7.8
		150 10 A100 S	10	150	179	20	35	100	Form A	-	7.8
	Diameter 12 mm	100 12 A100 S	12	100	129	24	33.7	100	Form A	-	7.8
		150 12 A100 S	12	150	179	24	39	100	Form A	-	7.8
	Diameter 16 mm	60 16 A100 S	16	60	89	32	37.5	100	Form A	-	7.8
		100 16 A100 S	16	100	129	32	41.7	100	Form A	-	7.8
		150 16 A100 S	16	150	179	32	46.9	100	Form A	-	7.8
	Diameter 20 mm	60 20 A100 S	20	60	89	40	40	100	Form A	-	7.8
	Diameter 25 mm	60 25 A100 S	25	60	89	46	46	100	Form A	-	7.8
	Diameter 32 mm	70 32 A100 S	32	70	99	44	53	100	Form A	-	7.8

The accessories shown here must be used for all sizes!	Accessories	KMR-100A	Coolant supply tube for HSK tooling	> Page 162
		WRENCHHSK100	Wrench for coolant tubes	> Page 162

HSK 100 form A

For shrink gripping | CoolCap®



Characteristics:

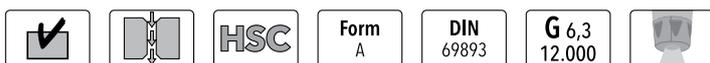

For shrink gripping CoolCap®	Order no.	d ₁	l ₃	A	d ₃	d ₄	d ₂	DIN / shape	l ₂	l ₁
--------------------------------	-----------	----------------	----------------	---	----------------	----------------	----------------	-------------	----------------	----------------

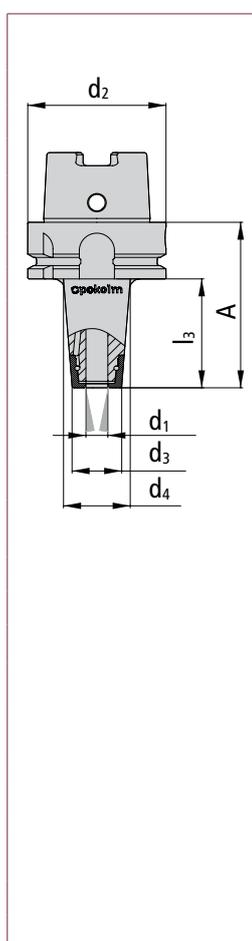

Diameter 6 mm	100 06 A100 SR1	6	100	129	16.5	32.3	100	Form A	–	–
Accessories	SR1 S06 SW17	CoolCap® screw-on cap diam. 6							> Page 162	
	SR1 A06 SW17	CoolCap® screw-on cap diam. 6							> Page 163	
Diameter 8 mm	100 08 A100 SR1	8	100	129	20.5	36.3	100	Form A	–	–
Accessories	SR1 S08 SW21	CoolCap® screw-on cap diam. 8							> Page 162	
	SR1 A08 SW21	CoolCap® screw-on cap diam. 8							> Page 163	
Diameter 10 mm	100 10 A100 SR1	10	100	129	22.5	38.3	100	Form A	–	–
Accessories	SR1 S10 SW22	CoolCap® screw-on cap diam. 10							> Page 162	
	SR1 A10 SW22	CoolCap® screw-on cap diam. 10							> Page 163	
Diameter 12 mm	100 12 A100 SR1	12	100	129	26.5	42.3	100	Form A	–	–
Accessories	SR1 S12 SW27	CoolCap® screw-on cap diam. 12							> Page 162	
	SR1 A12 SW27	CoolCap® screw-on cap diam. 12							> Page 163	
Diameter 16 mm	100 16 A100 SR1	16	100	129	31.5	47.3	100	Form A	–	–
Accessories	SR1 S16 SW32	CoolCap® screw-on cap diam. 16							> Page 162	
	SR1 A16 SW32	CoolCap® screw-on cap diam. 16							> Page 163	
Diameter 20 mm	100 20 A100 SR1	20	100	129	35.5	51.3	100	Form A	–	–
Accessories	SR1 S20 SW36	CoolCap® screw-on cap diam. 20							> Page 162	
	SR1 A20 SW36	CoolCap® screw-on cap diam. 20							> Page 163	

The accessories shown here must be used for all sizes!	Accessories	KMR-100A	Coolant supply tube for HSK tooling	> Page 162
		WRENCHSK100	Wrench for coolant tubes	> Page 162
		SR1 ZSW 002	CoolCap® application tool	> Page 163
		DMS 3/8 8-60 NM	Torque wrench 3/8"	> Page 163

The scope of delivery for each CoolCap® cooling arbor includes one cap. In your order, please indicate whether you would like a cap for air/MMS or a cap for emulsion/coolant. Other caps can be ordered separately. Only tighten and loosen caps using the application tool or ring wrench!

HSK 100 form A

for Weldon shank | CoolCap®

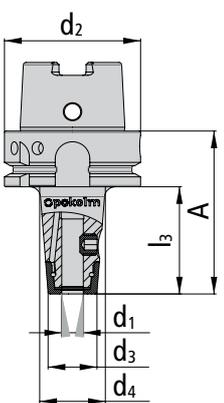

Characteristics:        

for Weldon shank CoolCap®	Order no.	d ₁	l ₃	A	d ₃	d ₄	d ₂	DIN / shape	l ₂	l ₁	
	Diameter 10 mm	100 10 A100 SR1 W	10	100	129	22.5	38.3	100	Form A	–	–
	Accessories	SR1 S10 SW22	CoolCap® screw-on cap diam. 10							> Page 162	
		SR1 A10 SW22	CoolCap® screw-on cap diam. 10							> Page 163	
		M10X9 SR1 W	Weldon diam. 10 straining screw							> Page 160	
Diameter 12 mm	100 12 A100 SR1 W	12	100	129	26.5	42.3	100	Form A	–	–	
Accessories	SR1 S12 SW27	CoolCap® screw-on cap diam. 10							> Page 162		
	SR1 A12 SW27	CoolCap® screw-on cap diam. 12							> Page 163		
	M12X10 SR1 W	Weldon diam. 12 straining screw							> Page 160		
Diameter 16 mm	100 16 A100 SR1 W	16	100	129	31.5	47.3	100	Form A	–	–	
Accessories	SR1 S16 SW32	SR1 S16 SW32 - CoolCap® screw-on cap diam. 16							> Page 162		
	SR1 A16 SW32	SR1 A16 SW32 - CoolCap® screw-on cap diam. 16							> Page 163		
	M14X11 SR1 W	Weldon diam. 16 straining screw							> Page 160		
Diameter 20 mm	100 20 A100 SR1 W	20	100	129	35.5	51.3	100	Form A	–	–	
Accessories	SR1 S20 SW36	CoolCap® screw-on cap diam. 20							> Page 162		
	SR1 A20 SW36	CoolCap® screw-on cap diam. 20							> Page 163		
	M16X10 SR1 W	Weldon diam. 20 straining screw							> Page 160		
The accessories shown here must be used for all sizes!	Accessories	KMR-100A	Coolant supply tube for HSK tooling							> Page 162	
		WRENCHHSK100	Wrench for coolant tubes							> Page 162	
		SR1 ZSW 002	CoolCap® application tool							> Page 163	
		DMS 3/8 8-60 NM	Torque wrench 3/8"							> Page 163	

The scope of delivery for each CoolCap® cooling arbor includes one cap. In your order, please indicate whether you would like a cap for air/MMS or a cap for emulsion/coolant. Other caps can be ordered separately. Only tighten and loosen caps using the application tool or ring wrench!

HSK 100 form A

for shell-type milling cutters

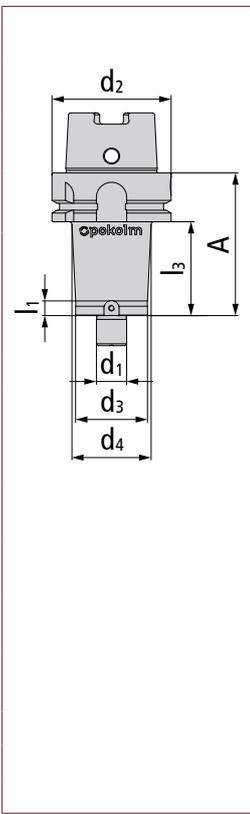

Characteristics:   **HSC**  **Form A**  **DIN 69893**  **G 6,3 12.000**

for shell-type milling cutter body	Order no.	d ₁	l ₃	A	d ₃	d ₄	d ₂	DIN / shape	l ₂	l ₁		
	Pilots Diameter 22 mm	50 22 A100	22	50	79	40	40	100	Form A	–	–	
		75 22 A100	22	75	104	48	48	100	Form A	–	–	
		100 22 A100	22	100	129	48	50	100	Form A	–	7.8	
		150 22 A100	22	150	179	48	50	100	Form A	–	7.8	
		200 22 A100	22	200	229	48	50	100	Form A	–	7.8	
	Accessories	DRIVING10X8	Driving block 10 x 8							> Page 161		
		M4X10	Screw for driving block 10 x 8							> Page 160		
		M10X35	Screw M10X35							> Page 161		
		Pilots Diameter 27 mm	50 27 A100	27	50	79	62	62	100	Form A	–	–
			75 27 A100	27	75	104	62	62	100	Form A	–	–
100 27 A100			27	100	129	62	71	100	Form A	–	7.8	
150 27 A100			27	150	179	62	80	100	Form A	–	7.8	
200 27 A100			27	200	229	62	80	100	Form A	–	7.8	
Accessories		DRIVING12X12/2	Driving block 12 x 12							> Page 161		
		M5X16	Screw for driving block 12 x 12							> Page 160		
		M12X35	Screw M12X35							> Page 161		
The accessories shown here must be used for all sizes!		Accessories	KMR-100A	Coolant supply tube for HSK tooling							> Page 162	
			WRENCHHSK100	Wrench for coolant tubes							> Page 162	
	4XGEBO-AUF		Threaded bores for adapter							> Page 164		

Note: To use the Pokolm shell-type adapter, the base arbors must be fitted with 4 threaded bores! This must be included in the order, and is implemented by additionally ordering the bores under the item number: 4XGEBO-AUF

1/2 >

HSK 100 form A

for shell-type milling cutters

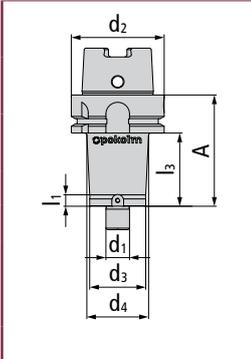

Characteristics:   **HSC** **Form A** **DIN 69893** **G 6,3 12.000**

for shell-type milling cutters	Order no.	d_1	l_3	A	d_3	d_4	d_2	DIN / shape	l_2	l_1	
	Pilots Diameter 32 mm	32	50	79	85	85	100	Form A	–	–	
	50 32 A100	32	50	79	85	85	100	Form A	–	–	
	100 32 A100	32	100	129	85	85	100	Form A	–	–	
	150 32 A100	32	150	179	85	85	100	Form A	–	–	
Accessories	M16X26	Screw M16X26						> Page 161			
<p>The accessories shown here must be used for all sizes!</p>	Accessories	DRIVING14X14	Driving block 14 x 14						> Page 161		
	M5X16	Screw for driving block 14 x 14						> Page 160			
	KMR-100A	Coolant supply tube for HSK tooling						> Page 162			
Accessories	WRENCHHSK100	Wrench for coolant tubes						> Page 162			
Pilots Diameter 40 mm	40	50	79	100	88	100	Form A	–	–		
50 40 A100	40	50	79	100	88	100	Form A	–	–		
Accessories	M20X30	Screw M20X30						> Page 161			

HSK 100 form A

for shell-type milling cutters (vibration-dampened)



Characteristics:       

for shell-type milling cutter body	Order no.	d_1	l_3	A	d_3	d_4	d_2	DIN / shape	l_2	l_1
------------------------------------	-----------	-------	-------	---	-------	-------	-------	-------------	-------	-------

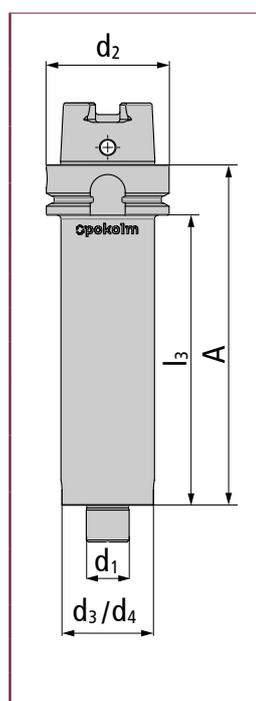

Bore diam. 16 mm	A300 16 A100 VD	16	271	300	38	38	63	Form A	-	-
	Accessories									
	DRIVING8X8	Driving block 8 x 8		> Page 161						
	M3X10	Screw for driving block 8 x 8		> Page 160						
	M8X30	Screw M8x30		> Page 161						

Bore diam. 22 mm	A200 22 A100 VD	22	171	200	48	48	63	Form A	-	-
	A300 22 A100 VD	22	271	300	48	48	63	Form A	-	-
Accessories										
	DRIVING10X8	Driving block 10 x 8		> Page 161						
	M4X10	Screw for driving block 10 x 8		> Page 160						
	M10X35	Screw M10X35		> Page 161						

The accessories shown here must be used for all sizes!	Accessories	KMR-63A	Coolant supply tube for HSK tooling	> Page 162
		WRENCHHSK63	Wrench for coolant tubes	> Page 162

1/2 >

HSK 100 form A

for shell-type milling cutters (vibration-dampened)

New



Characteristics:

-
-
- HSC**
- Form A**
- DIN 69893**
- G 6,3 8.000**
-

for shell-type milling cutters	Order no.	d_1	l_3	A	d_3	d_4	d_2	DIN / shape	l_2	l_1
--------------------------------	-----------	-------	-------	---	-------	-------	-------	-------------	-------	-------

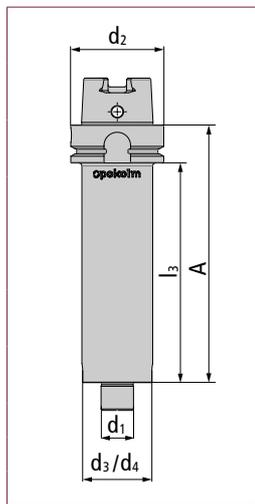

Bore diam. 27 mm	A200 27 A100 VD	27	171	200	58	58	100	Form A	-	-
	A300 27 A100 VD	27	271	300	58	58	100	Form A	-	-
Accessories	DRIVING12X8	Driving block 12 x 8		> Page 161						
	MSX12	Screw for driving block 12 x 8		> Page 160						
	M12X35	Screw M12 x 35		> Page 161						

The accessories shown here must be used for all sizes!

Accessories	KMR-63A	Coolant supply tube for HSK tooling	> Page 162
	WRENCHHSK63	Wrench for coolant tubes	> Page 162

HSK 100 form A

Drill chucks



Characteristics:

- 
- 
- Form A**
- DIN 69893**
-  7.000 1/min
- G 6,3 25.000**

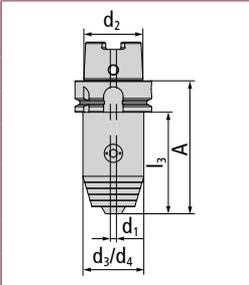
Drill chucks	Order no.	d ₁	l ₃	A	d ₃	d ₄	d ₂	DIN / shape	l ₂	l ₁		
	Diam. 0.5 to 13 mm	BF 0.5-13 A100 IC	13	89	118	50	50	100	Form A	–	–	
	Accessories	BF13DS06	Gasket 1306						> Page 163			
		BF13DS13	Gasket 1313						> Page 163			
	Diam. 2.5 to 16 mm	BF 2.5-16 A100 IC	16	83	112	57	57	100	Form A	–	–	
Accessories	BF16DS06	Gasket 1606						> Page 163				
	BF16DS16	Gasket 1616						> Page 163				
<p>The accessories shown here must be used for all sizes!</p>	Accessories	HEXA 6T	HEXA 6T						> Page 161			
		KMR-100A	Coolant supply tube for HSK tooling						> Page 162			
		WRENCHHSK100	Wrench for coolant tubes						> Page 162			
		BF13MW	Wrench 13/16						> Page 163			

The scope of delivery includes a hex key and gasket

PRODUCT VARIETY WITH THE HIGHEST PRECISION

Steep tapers SK | BT

At a glance

	Page
SK 30 ISO 7388-1 (formerly DIN 69871 AD)	for threaded shank end mills 98
	for shrinking 99
	for shrinking zero reach adapter 100
	HSC precision collet chucks ER 20 101
BT 30 ISO 7388-2 (formerly JIS B 6339 AD)	for threaded shank end mill 102
	for shrinking 103
	for shrinking zero reach adapter 104
	HSC precision collet chucks ER 20 105
SK 40 ISO 7388-1 (formerly DIN 69871 AD)	for threaded shank end mill 106
	for threaded shank end mills cylindrical 108
	for shrinking 109
	for shrinking reinforced design 111
	for shrinking zero reach adapter 112
	for shrinking CoolCap® 113
	for Weldon shank CoolCap® 115
	for shell-type milling cutters 116
	for shell-type milling cutters (vibration-dampened) 118
	HSC precision collet chucks ER 20 118
	Drill chucks 119
Hydro expansion zero reach adapter 120	
BT 40 ISO 7388-2 (formerly JIS B 6339 AD)	for threaded shank end mill 121
	for threaded shank end mills cylindrical 122
	for shrinking 123
	for shrinking zero reach adapter 125
	for shell-type milling cutters 126
	HSC precision collet chucks ER 20 128
SK 50 ISO 7388-1 (formerly DIN 69871 AD)	for threaded shank end mill 130
	for shrinking 131
	for shrinking zero reach adapter 133
	for shell-type milling cutters 134
	for shell-type milling cutters (vibration-dampened) 136
	Drill chucks 138
	For morse taper 139
Hydro expansion zero reach adapter 141	
BT 50 ISO 7388-2 (formerly JIS B 6339 AD)	for threaded shank end mill 142
	for shrinking 143
	for shrinking zero reach adapter 145
	for shell-type milling cutters 146
	Hydro expansion zero reach adapter 148

STEEP TAPERS SK / BT



Pokolm steep tapers

Features and advantages:

- Wide range of varieties available from stock
- SK 30-SK 50 and BT 30-BT 50 arbors available
- Thanks to complete in-house production, custom designs can even be created for your application.
- Shank tolerance H6
- High balancing precision
- Suitable for HSS and solid carbide tools
- Suitable for coolants and MMS
- Extended shrink adjustment for optimal holding forces
- Hardness 52-54 HRC
- Arbors made of high temperature-resistant material

SK 30 ISO 7388-1 (formerly DIN 69871 AD)

for threaded shank end mills

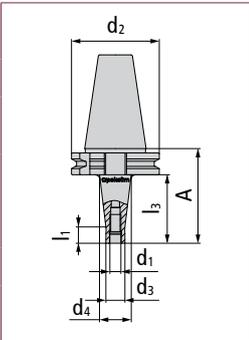

Characteristics:     

for threaded shank end mills	Order no.	d_1	l_3	A	d_3	d_4	d_2	DIN / shape	l_2	l_1	
	M 8	25 08 730	8	25	44.1	13.8	15	30	ISO 7388-1	-	12
	M 10	25 10 730	10	25	44.1	18	23	30	ISO 7388-1	-	12
	M 12	25 12 730	12	25	44.1	21	24	30	ISO 7388-1	-	12
	M 16	25 16 730	16	25	44.1	29	29	30	ISO 7388-1	-	-
The accessories shown here must be used for all sizes!	Accessories	KBSK30-69872A	retention knob with through-hole							> Page 162	
		KBSK30-69872B	retention knob without through-hole							> Page 162	

SK 30 ISO 7388-1 (formerly DIN 69871 AD)

for shrinking



Characteristics:

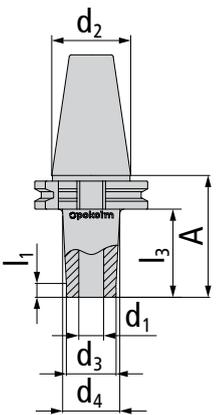

for shrinking	Order no.	d_1	l_3	A	d_3	d_4	d_2	DIN / shape	l_2	l_1	
	Diameter 3 mm	50 03 730 S.01	3	50	69.1	9	15.7	30	ISO 7388-1	–	7.8
	Diameter 4 mm	50 04 730 S.01	4	50	69.1	10.5	14.9	30	ISO 7388-1	–	7.8
	Diameter 6 mm	50 06 730 S	6	50	69.1	12	16.4	30	ISO 7388-1	–	7.8
	Diameter 8 mm	50 08 730 S	8	50	69.1	16	20.4	30	ISO 7388-1	–	7.8
	Diameter 10 mm	50 10 730 S	10	50	69.1	20	24.4	30	ISO 7388-1	–	7.8
	Diameter 12 mm	50 12 730 S	12	50	69.1	24	28.4	30	ISO 7388-1	–	7.8
	Diameter 16 mm	50 16 730 S	16	50	69.1	32	36.4	30	ISO 7388-1	–	7.8
The accessories shown here must be used for all sizes!	Accessories	KBSK30-69872A	retention knob with through-hole		> Page 162						
		KBSK30-69872B	retention knob without through-hole		> Page 162						

SK 30 ISO 7388-1 (formerly DIN 69871 AD)

for shrinking | zero reach adapters



Characteristics:

-
-
- HSC**
- G 2,5**
30.000
- ISO**
7388-1
-

for shrinking zero reach adapters	Order no.	d_1	l_3	A	d_3	d_4	d_2	DIN / shape	l_2	l_1
-------------------------------------	-----------	-------	-------	---	-------	-------	-------	-------------	-------	-------

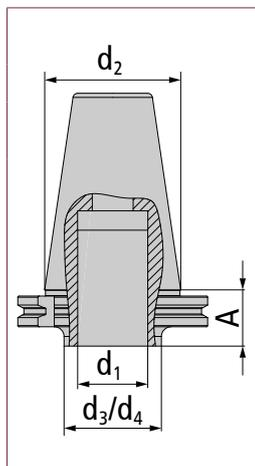

Diameter 16 mm	15 16 730 S	16	15	34.1	32	32	30	ISO 7388-1	-	-
Diameter 20 mm	15 20 730 S	20	15	34.1	40	40	30	ISO 7388-1	-	-

The accessories shown here must be used for all sizes!	Accessories		
		KBSK30-69872A	retention knob with through-hole
	KBSK30-69872B	retention knob without through-hole	> Page 162

Zero reach arbors cannot be ordered separately. They are shrunk at the factory with the corresponding solid carbide or dense antivibration material adapter (Please indicate the required adapter when placing your order!) and delivered ready for use. Relevant items are available in the section "Adapters, extensions and collet chucks" starting on page 26.

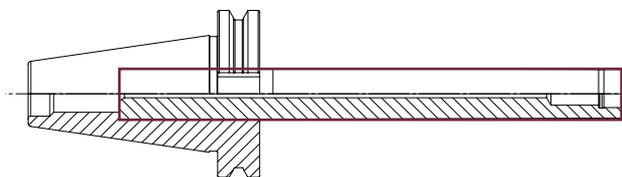

SK 30 ISO 7388-1 (formerly DIN 69871 AD)

HSC precision collet chucks ER 20



Characteristics:   **HSC** **G 2,5**
30.000 **ISO**
7388-1

HSC precision collet chucks ER 20	Order no.	d ₁	l ₃	A	d ₃	d ₄	d ₂	DIN / shape	l ₂	l ₁
-----------------------------------	-----------	----------------	----------------	---	----------------	----------------	----------------	-------------	----------------	----------------

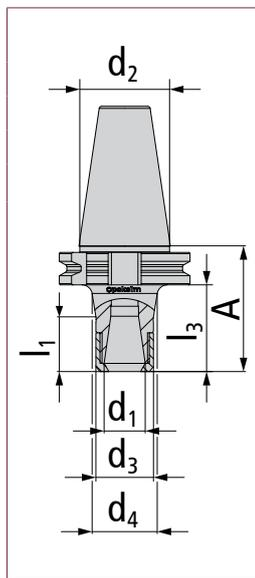

ER 20	50 ER20 730	20	50	69.1	28	32	30	ISO 7388-1	–	19.3
Accessories	ER20 001	Tightning nut							> Page 161	
	KBSK30-69872A	retention knob with through-hole							> Page 162	
	KBSK30-69872B	retention knob without through-hole							> Page 162	
	20 501	Collet chuck wrench for ER 20 tightening nut							> Page 161	

BT 30 ISO 7388-2 (formerly JIS B 6339 AD)

for threaded shank end mills

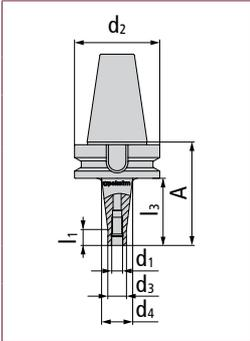

Characteristics:      

for threaded shank end mills	Order no.	d_1	l_3	A	d_3	d_4	d_2	DIN / shape	l_2	l_1	
	M 8	25 08 734	M 8	25	47	13.8	15	30	ISO 7388-2	-	12
	M 10	25 10 734	M 10	25	47	18	23	30	ISO 7388-2	-	12
	M 12	25 12 734	M 12	25	47	21	24	30	ISO 7388-2	-	12
	M 16	25 16 734	M 16	25	47	29	29	30	ISO 7388-2	-	12

BT 30 ISO 7388-2 (formerly JIS B 6339 AD)

for shrinking



Characteristics:





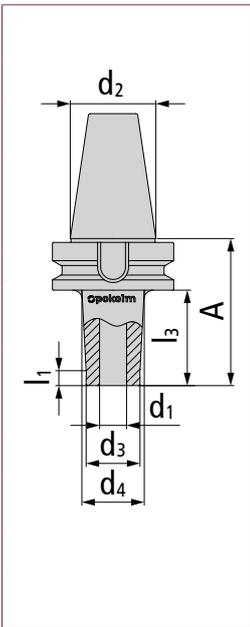

for shrinking	Order no.	d_1	l_3	A	d_3	d_4	d_2	DIN / shape	l_2	l_1	
	Diameter 3 mm	50 03 734 S.01	3	50	72	9	15.6	30	ISO 7388-2	-	7.8
	Diameter 4 mm	50 04 734 S.01	4	50	72	10.5	14.9	30	ISO 7388-2	-	7.8
	Diameter 6 mm	50 06 734 S	6	50	72	12	16	30	ISO 7388-2	-	7.8
	Diameter 8 mm	50 08 734 S	8	50	72	16	21	30	ISO 7388-2	-	7.8
	Diameter 10 mm	50 10 734 S	10	50	72	20	24.4	30	ISO 7388-2	-	7.8
	Diameter 12 mm	50 12 734 S	12	50	72	24	29	30	ISO 7388-2	-	7.8
	Diameter 16 mm	50 16 734 S	16	50	72	32	36.4	30	ISO 7388-2	-	7.8

BT 30 ISO 7388-2 (formerly JIS B 6339 AD)

for shrinking | zero reach adapters



Characteristics:

-
-
- HSC**
- Form BT
- G 2,5
30.000
-
- ISO 7388-2**

for shrinking zero reach adapters	Order no.	d_1	l_3	A	d_3	d_4	d_2	DIN / shape	l_2	l_1
-------------------------------------	-----------	-------	-------	---	-------	-------	-------	-------------	-------	-------

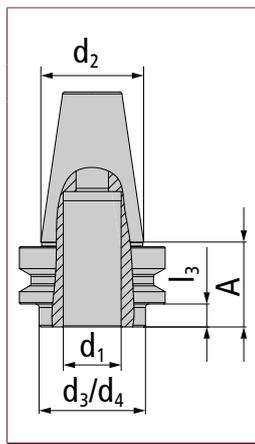

Diameter 16 mm	10 16 734 S	16	10	32	32	32	30	ISO 7388-2	-	-
Diameter 20 mm	15 20 734 S	20	15	37	40	40	30	ISO 7388-2	-	-

Zero reach arbors cannot be ordered separately. They are shrunk at the factory with the corresponding solid carbide or dense antivibration material adapter (Please indicate the required adapter when placing your order!) and delivered ready for use. Relevant items are available in the section "Adapters, extensions and collet chucks" starting on page 26.

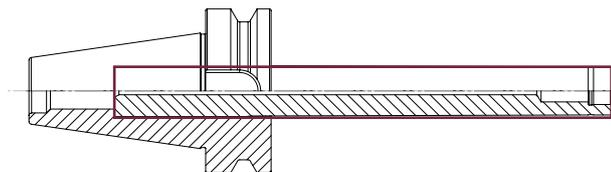

BT 30 ISO 7388-2 (formerly JIS B 6339 AD)

HSC precision collet chucks ER 20



Characteristics:   **HSC** **G 2,5**
30.000 **ISO**
7388-2

HSC precision collet chucks ER 20	Order no.	d ₁	l ₃	A	d ₃	d ₄	d ₂	DIN / shape	l ₂	l ₁
-----------------------------------	-----------	----------------	----------------	---	----------------	----------------	----------------	-------------	----------------	----------------

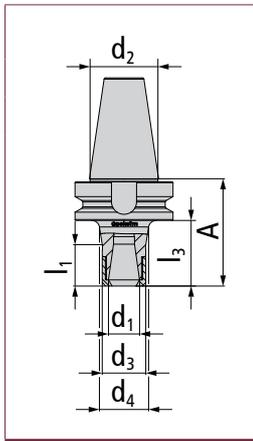

ER 20 mm	50 ER20 734	ER 20	50	72	28	32	30	ISO 7388-2	-	19.3
Accessories	ER20 001	Tightning nut							> Page 161	
	20 501	Collet chuck wrench for ER 20 tightening nut							> Page 161	

Scope of delivery includes a tightening nut, which is approved up to n = 80,000 1/min

SK 40 ISO 7388-1 (formerly DIN 69871 AD)

for threaded shank end mills



Characteristics:     

for threaded shank end mills	Order no.	d_1	l_3	A	d_3	d_4	d_2	DIN / shape	l_2	l_1
------------------------------	-----------	-------	-------	---	-------	-------	-------	-------------	-------	-------

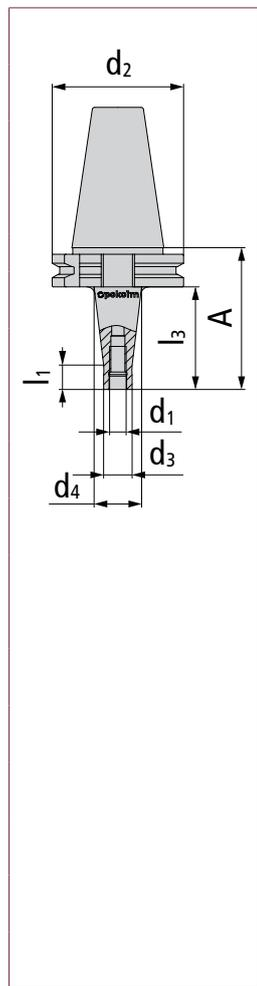

M 8	25 08 750	8	25	44.1	13.8	15	40	ISO 7388-1	-	12
	50 08 750	8	50	69.1	13.8	23	40	ISO 7388-1	-	12
	75 08 750	8	75	94.1	13.8	25	40	ISO 7388-1	-	12
	100 08 750	8	100	119.1	13.8	30	40	ISO 7388-1	-	12

M 10	25 10 750	10	25	44.1	18	23	40	ISO 7388-1	-	12
	50 10 750	10	50	69.1	18	25	40	ISO 7388-1	-	12
	75 10 750	10	75	94.1	18	30	40	ISO 7388-1	-	12
	100 10 750	10	100	119.1	18	35	40	ISO 7388-1	-	12
	125 10 750	10	125	144.1	18	40	40	ISO 7388-1	-	12
	150 10 750	10	150	169.1	18	45	40	ISO 7388-1	-	12

M 12	25 12 750	12	25	44.1	21	24	40	ISO 7388-1	-	12
	50 12 750	12	50	69.1	21	30	40	ISO 7388-1	-	12
	75 12 750	12	75	94.1	21	35	40	ISO 7388-1	-	12
	100 12 750	12	100	119.1	21	38	40	ISO 7388-1	-	12
	125 12 750	12	125	144.1	21	44	40	ISO 7388-1	-	12
	150 12 750	12	150	169.1	21	48	40	ISO 7388-1	-	12

The accessories shown here must be used for all sizes!	Accessories	KBSK40-69872A	retention knob with through-hole	> Page 162
		KBSK40-69872B	retention knob without through-hole	> Page 162

Characteristics:   **HSC** **G 6,3**
18.000 **ISO**
7388-1

for threaded shank end mills	Order no.	d ₁	l ₃	A	d ₅	d ₄	d ₂	DIN / shape	l ₂	l ₁
------------------------------	-----------	----------------	----------------	---	----------------	----------------	----------------	-------------	----------------	----------------

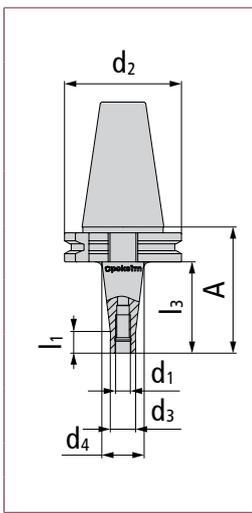

M 16	25 16 750	16	25	44.1	29	29	40	ISO 7388-1	–	–
	50 16 750	16	50	69.1	29	34	40	ISO 7388-1	–	12
	75 16 750	16	75	94.1	29	35	40	ISO 7388-1	–	12
	100 16 750	16	100	119.1	29	40	40	ISO 7388-1	–	12
	125 16 750	16	125	144.1	29	44	40	ISO 7388-1	–	12
	150 16 750	16	150	169.1	29	48	40	ISO 7388-1	–	12
	200 16 750	16	200	219.1	29	48	40	ISO 7388-1	–	12
	250 16 750	16	250	269.1	29	48	40	ISO 7388-1	–	12
Accessories	KBSK40-69872A		retention knob with through-hole						> Page 162	
	KBSK40-69872B		retention knob without through-hole						> Page 162	

<2/2

SK 40 ISO 7388-1 (formerly DIN 69871 AD)

for threaded shank milling | cylindrical

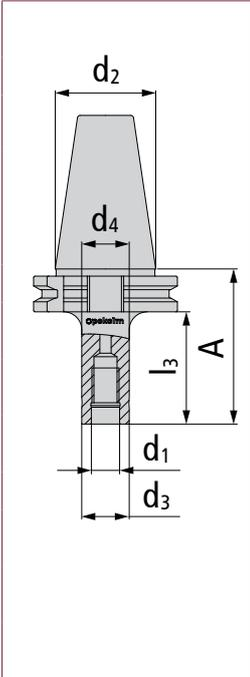

Characteristics:     

for threaded shank milling cylindrical		Order no.	d_1	l_3	A	d_3	d_4	d_2	DIN / shape	l_2	l_1
	M 8	50 08 750 ZYL	8	50	69.1	13.8	13.8	40	ISO 7388-1	-	-
	M 10	50 10 750 ZYL	10	50	69.1	18	18	40	ISO 7388-1	-	-
		75 10 750 ZYL	10	75	94.1	18	18	40	ISO 7388-1	-	-
		100 10 750 ZYL	10	100	119.1	18	18	40	ISO 7388-1	-	-
	M 12	50 12 750 ZYL	12	50	69.1	21	21	40	ISO 7388-1	-	-
		75 12 750 ZYL	12	75	94.1	21	21	40	ISO 7388-1	-	-
		100 12 750 ZYL	12	100	119.1	21	21	40	ISO 7388-1	-	-
	M 16	50 16 750 ZYL	16	50	69.1	29	29	40	ISO 7388-1	-	-
		75 16 750 ZYL	16	75	94.1	29	29	40	ISO 7388-1	-	-
		100 16 750 ZYL	16	100	119.1	29	29	40	ISO 7388-1	-	-
	The accessories shown here must be used for all sizes!	Accessories	KBSK40-69872A	retention knob with through-hole						> Page 162	
			KBSK40-69872B	retention knob without through-hole						> Page 162	

SK 40 ISO 7388-1 (formerly DIN 69871 AD)

for shrinking



Characteristics:



for shrinking	Order no.	d ₁	l ₃	A	d ₃	d ₄	d ₂	DIN / shape	l ₂	l ₁	
	Diameter 3 mm	50 03 750 S.01	3	50	69.1	9	15.6	40	ISO 7388-1	-	7.8
		100 03 750 S.01	3	100	119.1	9	23.5	40	ISO 7388-1	-	7.8
	Diameter 4 mm	50 04 750 S.01	4	50	69.1	10.5	14.9	40	ISO 7388-1	-	7.8
		75 04 750 S.01	4	75	94.1	10.5	17.54	40	ISO 7388-1	-	7.8
		100 04 750 S.01	4	100	119.1	10.5	20.16	40	ISO 7388-1	-	7.8
	Diameter 6 mm	50 06 750 S	6	50	69.1	12	16.4	40	ISO 7388-1	-	7.8
		75 06 750 S	6	75	94.1	12	19	40	ISO 7388-1	-	7.8
		100 06 750 S	6	100	119.1	12	21.7	40	ISO 7388-1	-	7.8
		150 06 750 S	6	150	169.1	12	27	40	ISO 7388-1	-	7.8
	Diameter 8 mm	50 08 750 S	8	50	69.1	16	20.4	40	ISO 7388-1	-	7.8
		75 08 750 S	8	75	94.1	16	23	40	ISO 7388-1	-	7.8
		100 08 750 S	8	100	119.1	16	25.7	40	ISO 7388-1	-	7.8
Diameter 10 mm	50 10 750 S	10	50	69.1	20	24.4	40	ISO 7388-1	-	7.8	
	75 10 750 S	10	75	94.1	20	27	40	ISO 7388-1	-	7.8	
	100 10 750 S	10	100	119.1	20	29.7	40	ISO 7388-1	-	7.8	
The accessories shown here must be used for all sizes!	Accessories	KBSK40-69872A	retention knob with through-hole					> Page 162			
		KBSK40-69872B	retention knob without through-hole					> Page 162			

SK 40 ISO 7388-1 (formerly DIN 69871 AD)

for shrinking

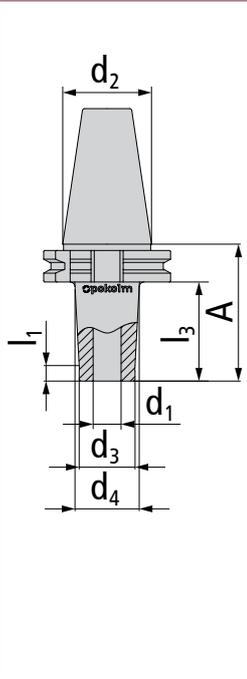

Characteristics:     

for shrinking	Order no.	d ₁	l ₃	A	d ₃	d ₄	d ₂	DIN / shape	l ₂	l ₁	
	Diameter 12	50 12 750 S	12	50	69.1	24	28.4	40	ISO 7388-1	-	7.8
		75 12 750 S	12	75	94.1	24	31	40	ISO 7388-1	-	7.8
		100 12 750 S	12	100	119.1	24	33.6	40	ISO 7388-1	-	7.8
	Diameter 16	50 16 750 S	16	50	69.1	32	36.4	40	ISO 7388-1	-	7.8
		75 16 750 S	16	75	94.1	32	39	40	ISO 7388-1	-	7.8
		100 16 750 S	16	100	119.1	32	41.7	40	ISO 7388-1	-	7.8
	Diameter 20	50 20 750 S	20	50	69.1	40	44.4	40	ISO 7388-1	-	7.8
		75 20 750 S	20	75	94.1	40	47	40	ISO 7388-1	-	7.8
		100 20 750 S	20	100	119.1	40	49	40	ISO 7388-1	-	7.8
	Diameter 25	60 25 750 S	25	60	79.1	45	45	40	ISO 7388-1	-	-
	The accessories shown here must be used for all sizes!	Accessories	KBSK40-69872A	retention knob with through-hole						> Page 162	
			KBSK40-69872B	retention knob without through-hole						> Page 162	

SK 40 ISO 7388-1 (formerly DIN 69871 AD)

for shrinking | reinforced design



Characteristics:



for shrinking reinforced design	Order no.	d_1	l_3	A	d_3	d_4	d_2	DIN / shape	l_2	l_1		
	Diameter 6 mm	50 06 750 SB	6	50	69.1	21	27.6	40	ISO 7388-1	–	7.8	
		100 06 750 SB	6	100	119.1	21	35.5	40	ISO 7388-1	–	7.8	
	Diameter 8 mm	50 08 750 SB	8	50	69.1	21	27.6	40	ISO 7388-1	–	7.8	
		100 08 750 SB	8	100	119.1	21	35.5	40	ISO 7388-1	–	7.8	
	Diameter 10 mm	50 10 750 SB	10	50	69.1	24	30.6	40	ISO 7388-1	–	7.8	
		100 10 750 SB	10	100	119.1	24	38.5	40	ISO 7388-1	–	7.8	
	Diameter 12 mm	50 12 750 SB	12	50	69.1	24	30.6	40	ISO 7388-1	–	7.8	
		100 12 750 SB	12	100	119.1	24	38.5	40	ISO 7388-1	–	7.8	
	The accessories shown here must be used for all sizes!	Accessories	KBSK40-69872A	retention knob with through-hole						> Page 162		
			KBSK40-69872B	retention knob without through-hole						> Page 162		

SK 40 ISO 7388-1 (formerly DIN 69871 AD)

for shrinking | zero reach adapters



Characteristics:

for shrinking zero reach adapters	Order no.	d_1	l_3	A	d_3	d_4	d_2	DIN / shape	l_2	l_1
-------------------------------------	-----------	-------	-------	---	-------	-------	-------	-------------	-------	-------

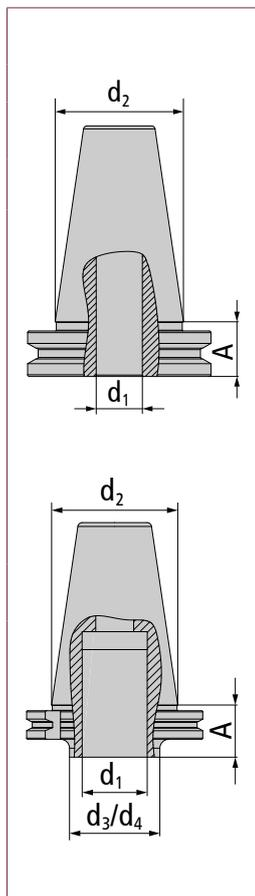

Diameter 16 mm	00 16 750 S	16	0	19.1	-	-	40	ISO 7388-1	-	-
-----------------------	-------------	----	---	------	---	---	----	------------	---	---

Diameter 20 mm	00 20 750 S	20	0	19.1	-	-	40	ISO 7388-1	-	-
-----------------------	-------------	----	---	------	---	---	----	------------	---	---

Diameter 25 mm	00 25 750 S	25	10	29.1	44	44	40	ISO 7388-1	-	-
-----------------------	-------------	----	----	------	----	----	----	------------	---	---

The accessories shown here must be used for all sizes!	Accessories	KBSK40-69872A	retention knob with through-hole	> Page 162
		KBSK40-69872B	retention knob without through-hole	> Page 162

Zero reach arbors cannot be ordered separately. They are shrunk at the factory with the corresponding solid carbide or dense antivibration material adapter (Please indicate the required adapter when placing your order!) and delivered ready for use. Relevant items are available in the section "Adapters, extensions and collet chucks" starting on page 26.

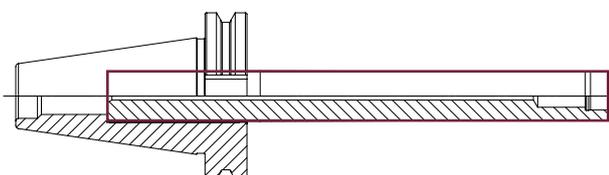

SK 40 ISO 7388-1 (formerly DIN 69871 AD)

for shrink gripping | CoolCap®



Characteristics:



for shrink gripping CoolCap®	Order no.	d ₁	l ₃	A	d ₃	d ₄	d ₂	DIN / shape	l ₂	l ₁
--------------------------------	-----------	----------------	----------------	---	----------------	----------------	----------------	-------------	----------------	----------------

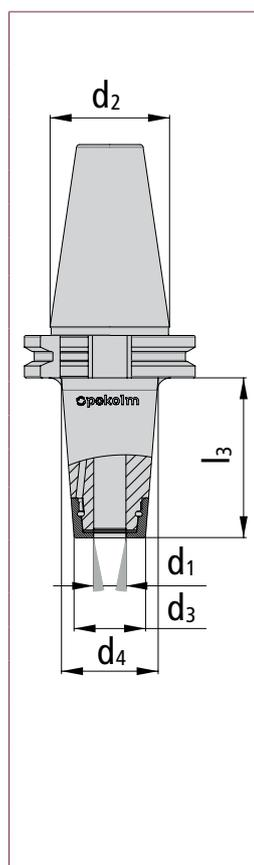

Diameter 4 mm	50 04 750 SR1	4	50	69.1	15	23.4	40	ISO 7388-1	-	-
	75 04 750 SR1	4	75	94.1	15	27.3	40	ISO 7388-1	-	-
	100 04 750 SR1	4	100	119.1	15	31.3	40	ISO 7388-1	-	-
Accessories	SR1 S04 SW15	CoolCap® screw-on cap diam. 4							> Page 162	
	SR1 A04 SW15	CoolCap® screw-on cap diam. 4							> Page 163	

Diameter 6 mm	50 06 750 SR1	6	50	69.1	16.5	24.4	40	ISO 7388-1	-	-
	100 06 750 SR1	6	100	119.1	16.5	32.3	40	ISO 7388-1	-	-
Accessories	SR1 S06 SW17	CoolCap® screw-on cap diam. 6							> Page 162	
	SR1 A06 SW17	CoolCap® screw-on cap diam. 6							> Page 163	

Diameter 8 mm	50 08 750 SR1	8	50	69.1	20.5	28.4	40	ISO 7388-1	-	-
	100 08 750 SR1	8	100	119.1	20.5	36.3	40	ISO 7388-1	-	-
Accessories	SR1 S08 SW21	CoolCap® screw-on cap diam. 8							> Page 162	
	SR1 A08 SW21	CoolCap® screw-on cap diam. 8							> Page 163	

Diameter 10 mm	50 10 750 SR1	10	50	69.1	22.5	30.4	40	ISO 7388-1	-	-
	100 10 750 SR1	10	100	119.1	22.5	38.3	40	ISO 7388-1	-	-
Accessories	SR1 S10 SW22	CoolCap® screw-on cap diam. 10							> Page 162	
	SR1 A10 SW22	CoolCap® screw-on cap diam. 10							> Page 163	

The accessories shown here must be used for all sizes!	Accessories	KBSK40-69872A	retention knob with through-hole							> Page 162	
		SR1 ZSW 002	CoolCap® application tool							> Page 163	
		DMS 3/8 8-60 NM	Torque wrench 3/8"							> Page 163	

The scope of delivery for each CoolCap® cooling arbor includes one cap. In your order, please indicate whether you would like a cap for air/MMS or a cap for emulsion/coolant. Other caps can be ordered separately. Only tighten and loosen caps using the application tool or ring wrench!

1/2 >

SK 40 ISO 7388-1 (formerly DIN 69871 AD)

for shrink gripping | CoolCap®

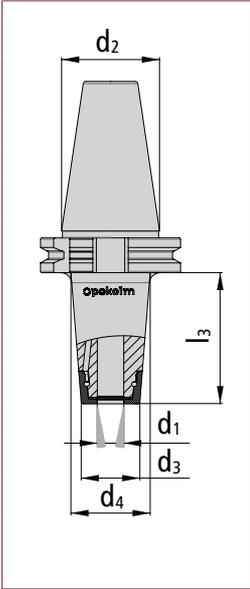

Characteristics:      

for shrink gripping CoolCap®		Order no.	d ₁	l ₃	A	d ₃	d ₄	d ₂	DIN / shape	l ₂	l ₁	
	Diameter 12 mm	60 12 750 SR1	12	60	79.1	26.5	36	40	ISO 7388-1	–	–	
		100 12 750 SR1	12	100	119.1	26.5	42.3	40	ISO 7388-1	–	–	
	Accessories	SR1 S12 SW27	CoolCap® screw-on cap diam. 12							> Page 162		
		SR1 A12 SW27	CoolCap® screw-on cap diam. 12							> Page 163		
	Diameter 16 mm	60 16 750 SR1	16	60	79.1	31.5	41	40	ISO 7388-1	–	–	
		100 16 750 SR1	16	100	119.1	31.5	47.3	40	ISO 7388-1	–	–	
Accessories	SR1 S16 SW32	CoolCap® screw-on cap diam. 16							> Page 162			
	SR1 A16 SW32	CoolCap® screw-on cap diam. 16							> Page 163			
Diameter 20 mm	60 20 750 SR1	20	60	79.1	36	45	40	ISO 7388-1	–	–		
	100 20 750 SR1	20	100	119.1	36	47	40	ISO 7388-1	–	–		
Accessories	SR1 S20 SW36	CoolCap® screw-on cap diam. 20							> Page 162			
	SR1 A20 SW36	CoolCap® screw-on cap diam. 20							> Page 163			
The accessories shown here must be used for all sizes!	Accessories	KBSK40-69872A	retention knob with through-hole							> Page 162		
		SR1 ZSW 002	CoolCap® application tool							> Page 163		
		DMS 3/8 8-60 NM	Torque wrench 3/8"							> Page 163		

The scope of delivery for each CoolCap® cooling arbor includes one cap. In your order, please indicate whether you would like a cap for air/MMS or a cap for emulsion/coolant. Other caps can be ordered separately. Only tighten and loosen caps using the application tool or ring wrench! <2/2

SK 40 ISO 7388-1 (formerly DIN 69871 AD)

for Weldon shank | CoolCap®



Characteristics:

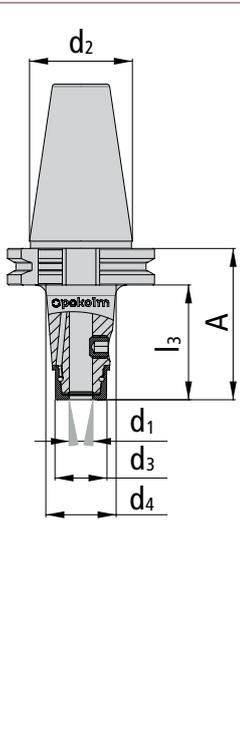

for Weldon shank CoolCap®	Order no.	d ₁	l ₃	A	d ₃	d ₄	d ₂	DIN / shape	l ₂	l ₁	
	Diameter 10 mm	50 10 750 SR1 W	10	50	69.1	22.5	30.4	40	ISO 7388-1	–	–
	Accessories	SR1 S10 SW22	CoolCap® screw-on cap diam. 10							> Page 162	
		SR1 A10 SW22	CoolCap® screw-on cap diam. 10							> Page 163	
		M10X9 SR1 W	Weldon diam. 10 straining screw							> Page 160	
	Diameter 12 mm	60 12 750 SR1 W	12	60	79.1	26.5	36	40	ISO 7388-1	–	–
	Accessories	SR1 S12 SW27	CoolCap® screw-on cap diam. 12							> Page 162	
		SR1 A12 SW27	CoolCap® screw-on cap diam. 12							> Page 163	
		M12X10 SR1 W	Weldon diam. 20 straining screw							> Page 160	
	Diameter 16 mm	60 16 750 SR1 W	16	60	79.1	31.5	41	40	ISO 7388-1	–	–
	Accessories	SR1 S16 SW32	CoolCap® screw-on cap diam. 16							> Page 162	
SR1 A16 SW32		CoolCap® screw-on cap diam. 16							> Page 163		
M14X11 SR1 W		Weldon diam. 16 straining screw							> Page 160		
Diameter 20 mm	60 20 750 SR1 W	20	60	79.1	36	45	40	ISO 7388-1	–	–	
Accessories	SR1 S20 SW36	CoolCap® screw-on cap diam. 20							> Page 162		
	SR1 A20 SW36	CoolCap® screw-on cap diam. 20							> Page 163		
	M16X10 SR1 W	Weldon diam. 20 straining screw							> Page 160		
The accessories shown here must be used for all sizes!	Accessories	KBSK40-69872A	retention knob with through-hole							> Page 162	
SR1 ZSW 002		CoolCap® application tool							> Page 163		
DMS 3/8 8-60 NM		Torque wrench 3/8"							> Page 163		

The scope of delivery for each CoolCap® cooling arbor includes one cap. In your order, please indicate whether you would like a cap for air/MMS or a cap for emulsion/coolant. Other caps can be ordered separately. Only tighten and loosen caps using the application tool or ring wrench!

SK 40 ISO 7388-1 (formerly DIN 69871 AD)

for shell-type milling cutters

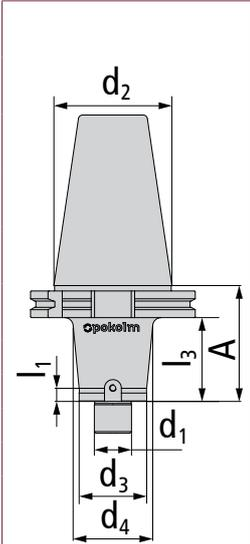

Characteristics:     

for shell-type milling cutters	Order no.	d ₁	l ₃	A	d ₃	d ₄	d ₂	DIN / shape	l ₂	l ₁	
	Bore diam. 16 mm	25 16 750 Z	16	25	44.1	38	40	ISO 7388-1	–	7.8	
		50 16 750 Z	16	50	69.1	38	42	ISO 7388-1	–	7.8	
		75 16 750 Z	16	75	94.1	38	45	ISO 7388-1	–	7.8	
		125 16 750 Z	16	125	144.1	38	50	ISO 7388-1	–	7.8	
		150 16 750 Z	16	150	169.1	38	50	ISO 7388-1	–	7.8	
		200 16 750 Z	16	200	219.1	38	50	ISO 7388-1	–	7.8	
	Accessories	DRIVING8X8	Driving block 8 x 8							> Page 161	
		M3X8	Screw for driving block 8 x 8							> Page 160	
		M8X30	Screw M8x30							> Page 161	
	Bore diam. 22 mm	25 22 750.01	22	25	44.1	48	48	40	ISO 7388-1	–	–
		50 22 750.01	22	50	69.1	48	48	40	ISO 7388-1	–	–
		75 22 750	22	75	94.1	48	48	40	ISO 7388-1	–	–
100 22 750		22	100	119.1	48	48	40	ISO 7388-1	–	–	
150 22 750		22	150	169.1	48	48	40	ISO 7388-1	–	–	
200 22 750		22	200	219.1	48	48	40	ISO 7388-1	–	–	
Accessories	DRIVING10X8	Driving block 10 x 8							> Page 161		
	M4X10	Screw for driving block 10 x 8							> Page 160		
	M10X35	Screw M10X35							> Page 161		
	4XGEB0-AUF	Threaded bores for adapter							> Page 164		
Accessories	KBSK40-69872A	retention knob with through-hole							> Page 162		
	KBSK40-69872B	retention knob without through-hole							> Page 162		

The accessories shown here must be used for all sizes!

Characteristics:

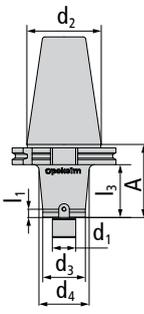

for shell-type milling cutters		Order no.	d ₁	l ₃	A	d ₃	d ₄	d ₂	DIN / shape	l ₂	l ₁
	Bore diam. 27 mm	15 27 750	27	15	34.1	48	48	40	ISO 7388-1	–	–
		50 27 750	27	50	69.1	48	48	40	ISO 7388-1	–	–
		75 27 750	27	75	94.1	48	48	40	ISO 7388-1	–	–
		100 27 750	27	100	119.1	48	48	40	ISO 7388-1	–	–
Accessories	DRIVING12X8	Driving block 12 x 8		> Page 161							
	M5X12	Screw for driving block 12 x 8		> Page 160							
	M12X35	Screw M12X35		> Page 160							
The accessories shown here must be used for all sizes!	Accessories	KBSK40-69872A	retention knob with through-hole		> Page 162						
		KBSK40-69872B	retention knob without through-hole		> Page 162						
		4XGEB0-AUF	Threaded bores for adapter		> Page 164						

<2/2

SK 40 ISO 7388-1 (formerly DIN 69871 AD)

for shell-type milling cutters (vibration-dampened)

New



Characteristics:

for shell-type milling cutters	Order no.	d ₁	l ₃	A	d ₃	d ₄	d ₂	DIN / shape	l ₂	l ₁	
	Bore diam. 16 mm	A200 16 750 VD	16	180.9	200	38	38	40	ISO 7388-1	–	–
		A300 16 750 VD	16	280.9	300	38	38	40	ISO 7388-1	–	–
	Accessories	DRIVING8X8	Driving block 8 x 8							> Page 161	
		M3X10	Screw for driving block 8 x 8							> Page 160	
		M8X30	Screw M8X30							> Page 161	
	Bore diam. 22 mm	A200 22 750 VD	22	180.9	200	48	48	40	ISO 7388-1	–	–
	A300 22 750 VD	22	280.9	300	48	48	40	ISO 7388-1	–	–	
Accessories	DRIVING10X8	Driving block 10 x 8							> Page 161		
	M4X10	Screw for driving block 10 x 8							> Page 160		
	M10X35	Screw M10X35							> Page 161		
The accessories shown here must be used for all sizes!	Accessories	KMR-63A	Coolant supply tube for HSK tooling							> Page 162	
		WRENCHHSK63	Wrench for coolant tubes							> Page 162	

SK 40 ISO 7388-1 (formerly DIN 69871 AD)

HSC precision collet chucks ER 20



Characteristics:

HSC precision collet chucks ER 20	Order no.	d ₁	l ₃	A	d ₃	d ₄	d ₂	DIN / shape	l ₂	l ₁	
	ER 20	50 ER20 750	20	50	69.1	28	36	40	ISO 7388-1	–	34.3
		100 ER20 750	20	100	119.1	28	40	40	ISO 7388-1	–	34.3
	Accessories	ER20 001	Tightning nut							> Page 161	
		20 501	Collet chuck wrench for ER 20 tightening nut							> Page 161	
		KBSK40-69872A	retention knob with through-hole							> Page 162	
	KBSK40-69872B	retention knob without through-hole							> Page 162		

Scope of delivery includes a tightening nut, which is approved up to n = 80,000 1/min

SK 40 ISO 7388-1 (formerly DIN 69871 AD)

Drill chucks



Characteristics:

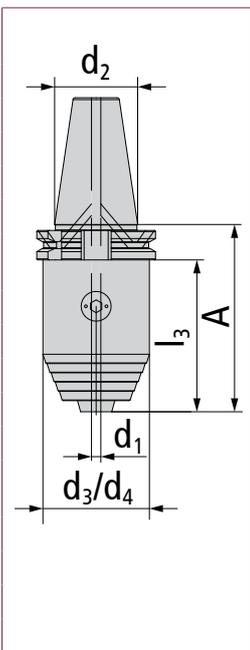

Drill chucks	Order no.	d_1	l_3	A	d_3	d_4	d_2	DIN / shape	l_2	l_1	
	Diam. 0.3 to 8 mm	BF 0.3-8 750 IC	8	57	76.1	36	36	40	ISO 7388-1	-	-
	Accessories	HEXA 4T	HEXA 4T		> Page 161						
		BF08DS04	Gasket 0804		> Page 163						
		BF08DS08	Gasket 0808		> Page 163						
		BF08MW	Wrench 08		> Page 163						
Diam. 0.5 to 13 mm	BF 0.5-13 750 IC	13	97	116.1	50	50	40	ISO 7388-1	-	-	
Accessories	HEXA 6T	HEXA 6T		> Page 161							
	BF13DS06	Gasket 1306		> Page 163							
	BF13DS13	Gasket 1313		> Page 163							
	BF13MW	Wrench 13/16		> Page 163							
Diam. 2.5 to 16 mm	BF 2.5-16 750 IC	16	82	101.1	57	57	40	ISO 7388-1	-	-	
Accessories	HEXA 6T	HEXA 6T		> Page 161							
	BF16DS06	Gasket 1606		> Page 163							
	BF16DS16	Gasket 1616		> Page 163							
	BF13MW	Wrench 13/16		> Page 163							
The accessories shown here must be used for all sizes!	Accessories	KBSK40-69872A	retention knob with through-hole		> Page 162						
		KBSK40-69872B	retention knob without through-hole		> Page 162						

Scope of delivery includes wrench and gasket

SK 40 ISO 7388-1 (formerly DIN 69871 AD)

Hydro expansion zero reach adapter



Characteristics:

-
-
-
- HSC**
- G 2,5**
25.000
- ISO**
7388-1

Hydro expansion zero reach adapter	Order no.	d ₁	l ₃	A	d ₃	d ₄	d ₂	DIN / shape	l ₂	l ₁
------------------------------------	-----------	----------------	----------------	---	----------------	----------------	----------------	-------------	----------------	----------------

	SK 40 diam. 20 mm	00 20 750 HDF	20	5.4	24.5	34	48	40	ISO 7388-1	–	–	
	Accessories											
		KBSK40-69872A									retention knob with through-hole	> Page 162
		KBSK40-69872B									retention knob without through-hole	> Page 162
		PHK20 6									Reduction to 6 mm diam. (not coolant-tight)	> Page 164
		PHK20 8									Reduction to 8 mm diam. (not coolant-tight)	> Page 164
		PHK20 10									Reduction to 10 mm diam. (not coolant-tight)	> Page 164
		PHK20 12									Reduction to 12 mm diam. (not coolant-tight)	> Page 164
		PHK20 14									Reduction to 14 mm diam. (not coolant-tight)	> Page 164
		PHK20 16									Reduction to 16 mm diam. (not coolant-tight)	> Page 164
		PHK20 3 IC									Reduction to 3 mm diam. (not coolant-tight)	> Page 164
		PHK20 4 IC									Reduction to 4 mm diam. (not coolant-tight)	> Page 164
		PHK20 5 IC									Reduction to 5 mm diam. (not coolant-tight)	> Page 164
		PHK20 6 IC									Reduction to 6 mm diam. (not coolant-tight)	> Page 164
		PHK20 8 IC									Reduction to 8 mm diam. (not coolant-tight)	> Page 164
		PHK20 10 IC									Reduction to 10 mm diam. (not coolant-tight)	> Page 164
		PHK20 12 IC									Reduction to 12 mm diam. (not coolant-tight)	> Page 164
		PHK20 14 IC									Reduction to 14 mm diam. (not coolant-tight)	> Page 164
		PHK20 16 IC									Reduction to 16 mm diam. (not coolant-tight)	> Page 164

Scope of delivery includes Allen wrench

BT 40 ISO 7388-2 (JIS B 6339 AD)

for threaded shank end mills



Characteristics:





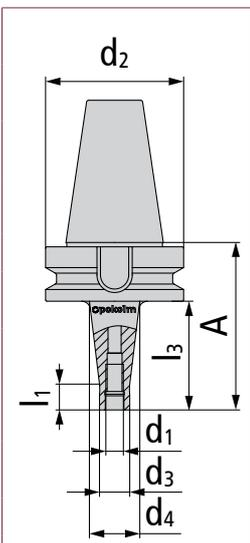

for threaded shank end mills	Order no.	d ₁	l ₃	A	d ₃	d ₄	d ₂	DIN / shape	l ₂	l ₁	
	M 8	25 08 754	M 8	25	52	13.8	15	40	ISO 7388-2	-	12
		50 08 754	M 8	50	77	13.8	23	40	ISO 7388-2	-	12
		75 08 754	M 8	75	102	13.8	25	40	ISO 7388-2	-	12
		100 08 754	M 8	100	127	13.8	30	40	ISO 7388-2	-	12
	M 10	25 10 754	M 10	25	52	18	23	40	ISO 7388-2	-	12
		50 10 754	M 10	50	77	18	25	40	ISO 7388-2	-	12
		75 10 754	M 10	75	102	18	30	40	ISO 7388-2	-	12
		100 10 754	M 10	100	127	18	35	40	ISO 7388-2	-	12
	M 12	25 12 754	M 12	25	52	21	24	40	ISO 7388-2	-	12
		50 12 754	M 12	50	77	21	30	40	ISO 7388-2	-	12
		75 12 754	M 12	75	102	21	35	40	ISO 7388-2	-	12
		100 12 754	M 12	100	127	21	38	40	ISO 7388-2	-	12
M 16	25 16 754	M 16	25	52	29	29	40	ISO 7388-2	-	-	
	50 16 754	M 16	50	77	29	34	40	ISO 7388-2	-	12	
	75 16 754	M 16	75	102	29	35	40	ISO 7388-2	-	12	
	100 16 754	M 16	100	127	29	40	40	ISO 7388-2	-	12	
	150 16 754	M 16	150	177	29	48	40	ISO 7388-2	-	12	

BT 40 ISO 7388-2 (JIS B 6339 AD)

for threaded shank milling | cylindrical



Characteristics:

-
-
- HSC**
- Form
BT
- G 6,3
18.000
- ISO
7388-2

for threaded shank milling cylindrical	Order no.	d ₁	l ₃	A	d ₃	d ₄	d ₂	DIN / shape	l ₂	l ₁	
	M 8	50 08 754 ZYL	M 8	50	77	13.8	13.8	40	ISO 7388-2	-	-
	M 10	50 10 754 ZYL	M 10	50	77	18	18	40	ISO 7388-2	-	-
		75 10 754 ZYL	M 10	75	102	18	18	40	ISO 7388-2	-	-
		100 10 754 ZYL	M 10	100	127	18	18	40	ISO 7388-2	-	-
	M 12	50 12 754 ZYL	M 12	50	77	21	21	40	ISO 7388-2	-	-
		75 12 754 ZYL	M 12	75	102	21	21	40	ISO 7388-2	-	-
		100 12 754 ZYL	M 12	100	127	21	21	40	ISO 7388-2	-	-
	M 16	50 16 754 ZYL	M 16	50	77	29	29	40	ISO 7388-2	-	-
		75 16 754 ZYL	M 16	75	102	29	29	40	ISO 7388-2	-	-
		100 16 754 ZYL	M 16	100	127	29	29	40	ISO 7388-2	-	-

BT 40 ISO 7388-2 (JIS B 6339 AD)

for shrinking



Characteristics:

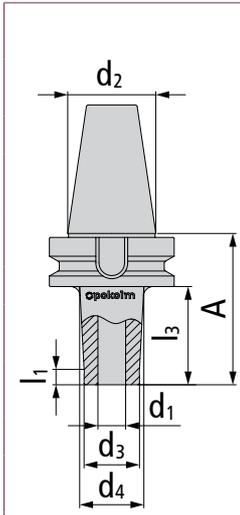

for shrinking	Order no.	d ₁	l ₃	A	d ₃	d ₄	d ₂	DIN / shape	l ₂	l ₁	
	Diameter 3 mm	50 03 754 S.01	3	50	77	9	15.6	40	ISO 7388-2	-	7.8
		100 03 754 S.01	3	100	127	9	23.5	40	ISO 7388-2	-	7.8
	Diameter 4 mm	50 04 754 S.01	4	50	77	10.5	14.9	40	ISO 7388-2	-	7.8
		100 04 754 S.01	4	100	127	10.5	20.2	40	ISO 7388-2	-	7.8
	Diameter 6 mm	50 06 754 S	6	50	77	12	16	40	ISO 7388-2	-	7.8
		100 06 754 S	6	100	127	12	21.7	40	ISO 7388-2	-	7.8
	Diameter 8 mm	50 08 754 S	8	50	77	16	21	40	ISO 7388-2	-	7.8
		100 08 754 S	8	100	127	16	25.7	40	ISO 7388-2	-	7.8
	Diameter 10 mm	50 10 754 S	10	50	77	20	24.4	40	ISO 7388-2	-	7.8
		100 10 754 S	10	100	127	20	29.7	40	ISO 7388-2	-	7.8
	Diameter 12 mm	50 12 754 S	12	50	77	24	29	40	ISO 7388-2	-	7.8
		100 12 754 S	12	100	127	24	33.7	40	ISO 7388-2	-	7.8
	Diameter 16 mm	50 16 754 S	16	50	77	32	36.4	40	ISO 7388-2	-	7.8
		100 16 754 S	16	100	127	32	41.7	40	ISO 7388-2	-	7.8
Diameter 20 mm	50 20 754 S	20	50	77	40	44.4	40	ISO 7388-2	-	7.8	

BT 40 ISO 7388-2 (JIS B 6339 AD)

for shrinking



Characteristics:

-
-
- HSC**
- Form
BT
- G 6,3
18.000
- ISO
7388-2

for shrinking	Order no.	d_1	l_3	A	d_3	d_4	d_2	DIN / shape	l_2	l_1
---------------	-----------	-------	-------	---	-------	-------	-------	-------------	-------	-------

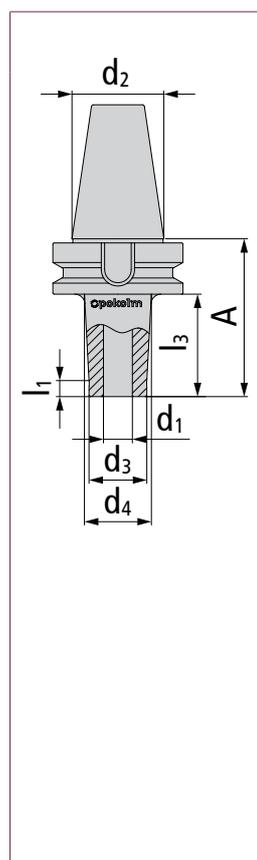

Diameter 25 mm	60 25 754 S	25	60	87	46	46	40	ISO 7388-2	-	7.8
--------------------------	-------------	----	----	----	----	----	----	------------	---	-----

<2/2

BT 40 ISO 7388-2 (JIS B 6339 AD)

for shrinking | zero reach adapters



Characteristics:

-
-
- HSC**
- Form BT
- G 6,3
18.000
-
- ISO 7388-2

for shrinking zero reach adapters	Order no.	d_1	l_3	A	d_3	d_4	d_2	DIN / shape	l_2	l_1	
	Diameter 16 mm	00 16 754 S	16	0	27	-	-	40	ISO 7388-2	-	-
	Diameter 20 mm	00 20 754 S	20	0	27	-	-	40	ISO 7388-2	-	-
	Diameter 25 mm	00 25 754 S	25	10	37	46	46	40	ISO 7388-2	-	-

Zero reach arbors cannot be ordered separately. They are shrunk at the factory with the corresponding solid carbide or dense antivibration material adapter (Please indicate the required adapter when placing your order!) and delivered ready for use. Relevant items are available in the section "Adapters, extensions and collet chucks" starting on page 26.

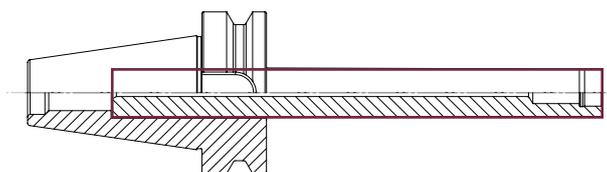

BT 40 ISO 7388-2 (JIS B 6339 AD)

for shell-type milling cutters



Characteristics:

-
-
- HSC**
- Form BT**
- G 6,3**
18.000
- ISO**
7388-2

for shell-type milling cutters	Order no.	d_1	l_3	A	d_3	d_4	d_2	DIN / shape	l_2	l_1		
	Bore diam. 16 mm	25 16 754 Z	16	25	52	38	40	ISO 7388-2	–	7.8		
		50 16 754 Z	16	50	77	38	42	40	ISO 7388-2	–	7.8	
		75 16 754 Z	16	75	102	38	45	40	ISO 7388-2	–	7.8	
		100 16 754 Z	16	100	127	38	48	40	ISO 7388-2	–	7.8	
		150 16 754 Z	16	150	177	38	50	40	ISO 7388-2	–	7.8	
	Accessories	DRIVING8X8		Driving block 8 x 8						> Page 161		
		M3X10		Screw for driving block 8 x 8						> Page 160		
		M8X30		Screw M8x30						> Page 161		
		Bore diam. 22 mm	25 22 754.01	22	25	52	48	48	40	ISO 7388-2	–	–
			50 22 754.01	22	50	77	48	48	40	ISO 7388-2	–	7.8
75 22 754			22	75	102	48	48	40	ISO 7388-2	–	7.8	
100 22 754			22	100	127	48	48	40	ISO 7388-2	–	7.8	
150 22 754			22	150	177	48	48	40	ISO 7388-2	–	7.8	
200 22 754			22	200	227	48	48	40	ISO 7388-2	–	7.8	
Accessories		DRIVING10X8		Driving block 10 x 8						> Page 161		
		M4X10		Screw for driving block 10 x 8						> Page 160		
		M10X35		Screw M10X35						> Page 161		
		4XGEBO-AUF		Threaded bores for adapter						> Page 164		

Note: To use the Pokolm shell-type adapter, the base arbors must be fitted with 4 threaded bores! This must be included in the order, and is implemented by additionally ordering the bores under the item number: 4XGEBO-AUF

Characteristics:   **HSC**  **Form BT**  **G 6,3 18.000**  **ISO 7388-2**

for shell-type milling cutters	Order no.	d ₁	l ₃	A	d ₃	d ₄	d ₂	DIN / shape	l ₂	l ₁
--------------------------------	-----------	----------------	----------------	---	----------------	----------------	----------------	-------------	----------------	----------------

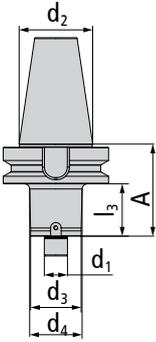
	Bore diam. 27 mm	15 27 754	27	15	42	48	48	40	ISO 7388-2	-	-
		50 27 754	27	50	77	48	48	40	ISO 7388-2	-	-
		75 27 754	27	75	102	48	48	40	ISO 7388-2	-	-
		100 27 754	27	100	127	48	48	40	ISO 7388-2	-	-
		150 27 754	27	150	177	48	48	40	ISO 7388-2	-	-
Accessories	DRIVING12X8	Driving block 12 x 8							> Page 161		
	M5X12	Screw for driving block 12 x 8							> Page 160		
	M12X35	Screw M12X35							> Page 161		
	4XGEBO-AUF	Threaded bores for adapter							> Page 164		

Note: To use the Pokolm shell-type adapter, the base arbors must be fitted with 4 threaded bores! This must be included in the order, and is implemented by additionally ordering the bores under the item number: 4XGEBO-AUF

<2/2

BT 40 ISO 7388-2 (JIS B 6339 AD)

HSC precision collet chucks ER 20



Characteristics:

-
-
- HSC**
- Form BT**
- G 6,3 18.000**
- ISO 7388-2**

HSC precision collet chucks ER 20	Order no.	d_1	l_3	A	d_3	d_4	d_2	DIN / shape	l_2	l_1
-----------------------------------	-----------	-------	-------	---	-------	-------	-------	-------------	-------	-------

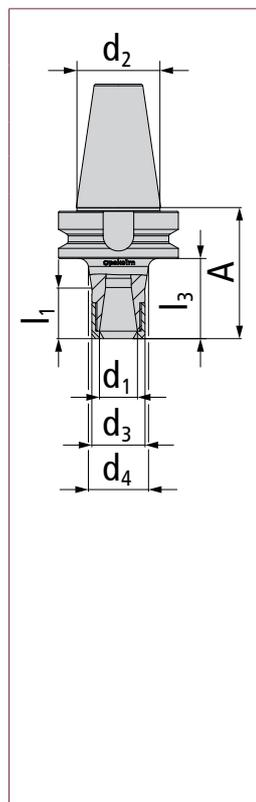

ER 20	50 ER20 754	ER 20	50	77	28	32	40	ISO 7388-2	-	34.3	
	100 ER20 754	ER 20	100	127	28	40	40	ISO 7388-2	-	34.3	
Accessories	ER20 001	Tightning nut							> Page 161		
	20 501	Collet chuck wrench for ER 20 tightening nut							> Page 161		

Scope of delivery includes a tightening nut, which is approved up to $n = 80,000$ 1/min

BT 40 ISO 7388-2 (JIS B 6339 AD)

Hydro expansion zero reach adapter



Characteristics:



Hydro expansion zero reach adapter	Order no.	d_1	l_3	A	d_3	d_4	d_2	DIN / shape	l_2	l_1
------------------------------------	-----------	-------	-------	---	-------	-------	-------	-------------	-------	-------

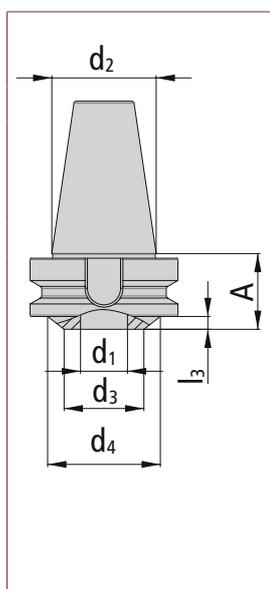

BT 40 Diameter 20 mm	00 20 754 HDF	20	5.5	32.5	34	48	40	ISO 7388-2	-	-
Accessories	PHK20 6	Reduction to 6 mm diam. (not coolant-tight)							> Page 164	
	PHK20 8	Reduction to 8 mm diam. (not coolant-tight)							> Page 164	
	PHK20 10	Reduction to 10 mm diam. (not coolant-tight)							> Page 164	
	PHK20 12	Reduction to 12 mm diam. (not coolant-tight)							> Page 164	
	PHK20 14	Reduction to 14 mm diam. (not coolant-tight)							> Page 164	
	PHK20 16	Reduction to 16 mm diam. (not coolant-tight)							> Page 164	
	PHK20 3 IC	Reduction to 3 mm diam. (not coolant-tight)							> Page 164	
	PHK20 4 IC	Reduction to 4 mm diam. (not coolant-tight)							> Page 164	
	PHK20 5 IC	Reduction to 5 mm diam. (not coolant-tight)							> Page 164	
	PHK20 6 IC	Reduction to 6 mm diam. (not coolant-tight)							> Page 164	
	PHK20 8 IC	Reduction to 8 mm diam. (not coolant-tight)							> Page 164	
	PHK20 10 IC	Reduction to 10 mm diam. (not coolant-tight)							> Page 164	
	PHK20 12 IC	Reduction to 12 mm diam. (not coolant-tight)							> Page 164	
	PHK20 14 IC	Reduction to 14 mm diam. (not coolant-tight)							> Page 164	
	PHK20 16 IC	Reduction to 16 mm diam. (not coolant-tight)							> Page 164	

Scope of delivery includes Allen wrench

SK 50 ISO 7388-1 (formerly DIN 69871 AD)

for threaded shank end mills



Characteristics:

-
-
- G 6,3**
12.000
- ISO**
7388-1

for threaded shank end mills	Order no.	d_1	l_3	A	d_3	d_4	d_2	DIN / shape	l_2	l_1		
	M 10	50 10 710	10	50	69.1	18	25	50	ISO 7388-1	–	12	
		75 10 710	10	75	94.1	18	30	50	ISO 7388-1	–	12	
		100 10 710	10	100	119.1	18	35	50	ISO 7388-1	–	12	
		150 10 710	10	150	169.1	18	45	50	ISO 7388-1	–	12	
	M 12	50 12 710	12	50	69.1	21	30	50	ISO 7388-1	–	12	
		100 12 710	12	100	119.1	21	38	50	ISO 7388-1	–	12	
		150 12 710	12	150	169.1	21	52	50	ISO 7388-1	–	12	
		200 12 710	12	200	219.1	21	68	50	ISO 7388-1	–	12	
		250 12 710	12	250	269.1	21	63	50	ISO 7388-1	–	12	
		300 12 710	12	300	319.1	21	68	50	ISO 7388-1	–	12	
	M 16	50 16 710	16	50	69.1	29	34	50	ISO 7388-1	–	12	
		100 16 710	16	100	119.1	29	40	50	ISO 7388-1	–	12	
		150 16 710	16	150	169.1	29	48	50	ISO 7388-1	–	12	
		200 16 710	16	200	219.1	29	50	50	ISO 7388-1	–	12	
		250 16 710	16	250	269.1	29	62	50	ISO 7388-1	–	12	
		300 16 710	16	300	319.1	29	68	50	ISO 7388-1	–	12	
	The accessories shown here must be used for all sizes!	Accessories	KBSK50-69872A	retention knob with through-hole						> Page 162		
			KBSK50-69872B	retention knob without through-hole						> Page 162		

SK 50 ISO 7388-1 (formerly DIN 69871 AD)

for shrinking



Characteristics:



for shrinking	Order no.	d ₁	l ₃	A	d ₃	d ₄	d ₂	DIN / shape	l ₂	l ₁
---------------	-----------	----------------	----------------	---	----------------	----------------	----------------	-------------	----------------	----------------

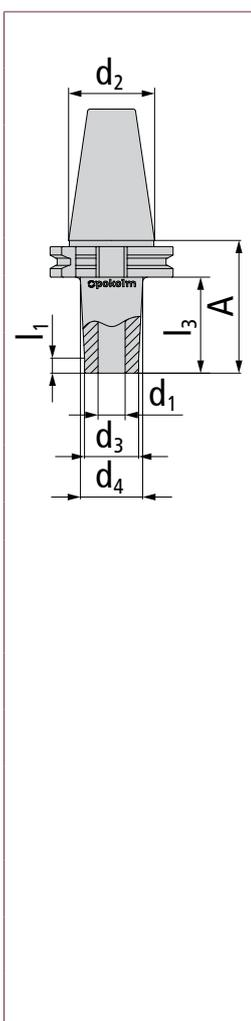

Diameter 6 mm	50 06 710 S	6	50	69.1	12	17	50	ISO 7388-1	-	7.8
	100 06 710 S	6	100	119.1	12	21.7	50	ISO 7388-1	-	7.8
	150 06 710 S	6	150	169.1	12	27	50	ISO 7388-1	-	7.8
	200 06 710 S	6	200	219.1	12	32	50	ISO 7388-1	-	7.8
Diameter 8 mm	50 08 710 S	8	50	69.1	16	21	50	ISO 7388-1	-	7.8
	100 08 710 S	8	100	119.1	16	26	50	ISO 7388-1	-	7.8
	150 08 710 S	8	150	169.1	16	30.9	50	ISO 7388-1	-	7.8
	200 08 710 S	8	200	219.1	16	36	50	ISO 7388-1	-	7.8
Diameter 10 mm	50 10 710 S	10	50	69.1	20	25	50	ISO 7388-1	-	7.8
	100 10 710 S	10	100	119.1	20	30	50	ISO 7388-1	-	7.8
	150 10 710 S	10	150	169.1	20	35	50	ISO 7388-1	-	7.8
	200 10 710 S	10	200	219.1	20	40	50	ISO 7388-1	-	7.8
Diameter 12 mm	50 12 710 S	12	50	69.1	24	28.4	50	ISO 7388-1	-	7.8
	100 12 710 S	12	100	119.1	24	33.7	50	ISO 7388-1	-	7.8
	150 12 710 S	12	150	169.1	24	39	50	ISO 7388-1	-	7.8
	200 12 710 S	12	200	219.1	24	44	50	ISO 7388-1	-	7.8

The accessories shown here must be used for all sizes!	Accessories	KBSK50-69872A	retention knob with through-hole	> Page 162
		KBSK50-69872B	retention knob without through-hole	> Page 162

SK 50 ISO 7388-1 (formerly DIN 69871 AD)

for shrinking

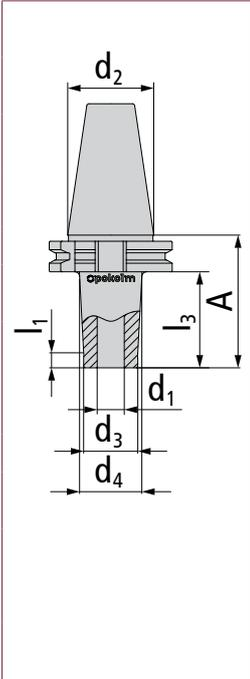

Characteristics:     

for shrinking	Order no.	d_1	l_3	A	d_3	d_4	d_2	DIN / shape	l_2	l_1		
	Diameter 16 mm	50 16 710 S	16	50	69.1	32	36.4	50	ISO 7388-1	-	7.8	
		100 16 710 S	16	100	119.1	32	41.7	50	ISO 7388-1	-	7.8	
		150 16 710 S	16	150	169.1	32	46.9	50	ISO 7388-1	-	7.8	
		200 16 710 S	16	200	219.1	32	52	50	ISO 7388-1	-	7.8	
	Diameter 20 mm	50 20 710 S	20	50	69.1	40	44.4	50	ISO 7388-1	-	7.8	
		100 20 710 S	20	100	119.1	40	50	50	ISO 7388-1	-	7.8	
		150 20 710 S	20	150	169.1	40	55	50	ISO 7388-1	-	7.8	
	Diameter 25 mm	60 25 710 S	25	60	79.1	46	46	50	ISO 7388-1	-	-	
		100 25 710 S	25	100	119.1	46	56	50	ISO 7388-1	-	7.8	
	Diameter 32 mm	60 32 710 S	32	60	79.1	44	53	50	ISO 7388-1	-	-	
	The accessories shown here must be used for all sizes!	Accessories	KBSK50-69872A	retention knob with through-hole						> Page 162		
			KBSK50-69872B	retention knob without through-hole						> Page 162		

SK 50 ISO 7388-1 (formerly DIN 69871 AD)

for shrinking | zero reach adapters



Characteristics:

-
-
-
- G 6,3**
12.000
- ISO**
7388-1

for shrinking zero reach adapters	Order no.	d_1	l_3	A	d_3	d_4	d_2	DIN / shape	l_2	l_1
-------------------------------------	-----------	-------	-------	---	-------	-------	-------	-------------	-------	-------

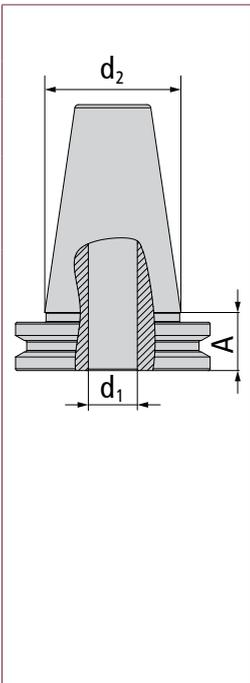

Diameter 20 mm	00 20 710 S	20	0	19.1	-	-	50	ISO 7388-1	-	-
Diameter 25 mm	00 25 710 S	25	0	19.1	-	-	50	ISO 7388-1	-	-
Diameter 32 mm	00 32 710 S	32	0	19.1	-	-	50	ISO 7388-1	-	-

The accessories shown here must be used for all sizes!	Accessories		
		KBSK50-69872A	retention knob with through-hole
	KBSK50-69872B	retention knob without through-hole	> Page 162

Zero reach arbors cannot be ordered separately. They are shrunk at the factory with the corresponding solid carbide or dense antivibration material adapter (Please indicate the required adapter when placing your order!) and delivered ready for use. Relevant items are available in the section "Adapters, extensions and collet chucks" starting on page 26.

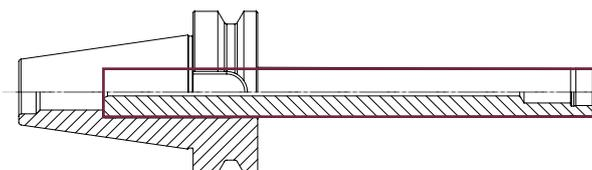

SK 50 ISO 7388-1 (formerly DIN 69871 AD)

for shell-type milling cutters



Characteristics:   **G 6,3**
12.000 **ISO**
7388-1

for shell-type milling cutters	Order no.	d ₁	l ₃	A	d ₃	d ₄	d ₂	DIN / shape	l ₂	l ₁
--------------------------------	-----------	----------------	----------------	---	----------------	----------------	----------------	-------------	----------------	----------------

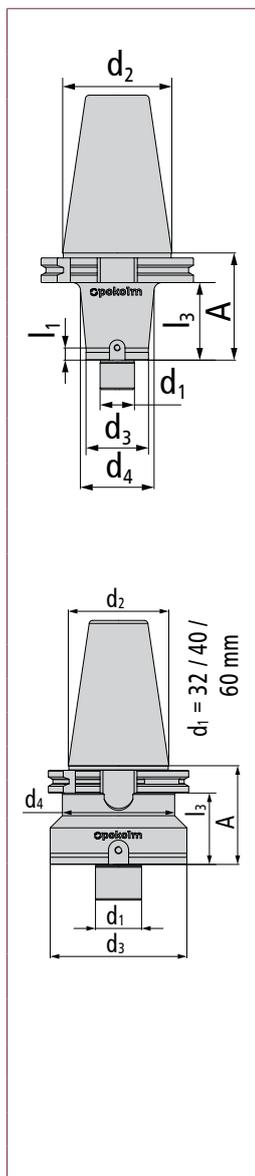

Bore diam. 16 mm	50 16 710 Z	16	50	69.1	38	42	50	ISO 7388-1	–	7.8	
	100 16 710 Z	16	100	119.1	38	50	50	ISO 7388-1	–	7.8	
	150 16 710 Z	16	150	169.1	38	50	50	ISO 7388-1	–	7.8	
	200 16 710 Z	16	200	219.1	38	50	50	ISO 7388-1	–	7.8	
	250 16 710 Z	16	250	269.1	38	50	50	ISO 7388-1	–	7.8	
Accessories	DRIVING8X8	Driving block 8 x 8								> Page 161	
	M3X10	Screw for driving block 8 x 8								> Page 161	
	M8X30	Screw M8x30								> Page 161	

Bore diam. 22 mm	50 22 710	22	50	69.1	40	40	50	ISO 7388-1	–	7.8	
	50 22 710.01	22	50	69.1	48	48	50	ISO 7388-1	–	7.8	
	100 22 710	22	100	119.1	40	50	50	ISO 7388-1	–	7.8	
	150 22 710	22	150	169.1	48	62	50	ISO 7388-1	–	7.8	
	200 22 710	22	200	219.1	48	78	50	ISO 7388-1	–	7.8	
	250 22 710	22	250	269.1	48	78	50	ISO 7388-1	–	7.8	
Accessories	DRIVING10X8	Driving block 10 x 8								> Page 161	
	M4X10	Screw for driving block 10 x 8								> Page 161	
	M10X35	Screw M10X35								> Page 161	
	4XGEB0-AUF	Threaded bores for adapter								> Page 164	

Bore diam. 27 mm	50 27 710	27	50	69.1	62	62	50	ISO 7388-1	–	–	
	100 27 710	27	100	119.1	62	70	50	ISO 7388-1	–	7.8	
	150 27 710	27	150	169.1	62	76	50	ISO 7388-1	–	7.8	
	200 27 710	27	200	219.1	62	76	50	ISO 7388-1	–	7.8	
	250 27 710	27	250	269.1	62	76	50	ISO 7388-1	–	7.8	
Accessories	DRIVING12X12/2	Driving block 12 x 12								> Page 161	
	M5X12	Screw for driving block 12 x 8								> Page 160	
	M12X35	Screw M12X35								> Page 161	
	4XGEB0-AUF	Threaded bores for adapter								> Page 164	

The accessories shown here must be used for all sizes!	Accessories	KBSK50-69872A	retention knob with through-hole	> Page 162
		KBSK50-69872B	retention knob without through-hole	> Page 162

Characteristics:



G 6,3
12.000

ISO
7388-1

for shell-type milling cutters	Order no.	d ₁	l ₃	A	d ₃	d ₄	d ₂	DIN / shape	l ₂	l ₁
--------------------------------	-----------	----------------	----------------	---	----------------	----------------	----------------	-------------	----------------	----------------

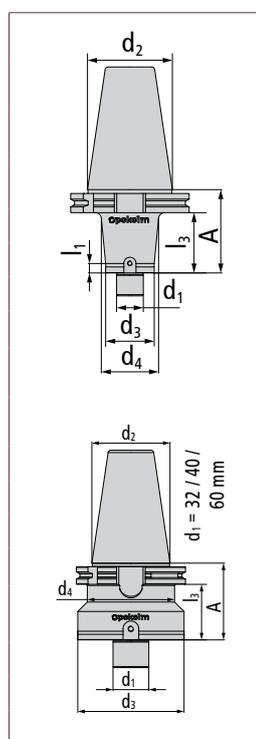

Bore diam. 32 mm	50 32 710	32	50	69.1	95	78	50	ISO 7388-1	–	7.8
	100 32 710	32	100	119.1	95	78	50	ISO 7388-1	–	7.8
	150 32 710	32	150	169.1	95	78	50	ISO 7388-1	–	7.8
	200 32 710	32	200	219.1	95	78	50	ISO 7388-1	–	7.8
Accessories	DRIVING14X14	Driving block 14 x 14							> Page 161	
	M5X16	Screw for driving block 12 x 12 and 14 x 14							> Page 160	
	M16X26	Screw M16X26							> Page 161	

Bore diam. 40 mm	50 40 710 Z	40	50	69.1	100	78	50	ISO 7388-1	–	–
	100 40 710 Z	40	100	119.1	100	78	50	ISO 7388-1	–	–
Accessories	DRIVING16X16	Driving block 16 x 16							> Page 161	
	M6X16	Screw for driving block 16 x 16							> Page 160	
	M20X30	Screw M20X30							> Page 161	

Bore diam. 60 mm	50 60 710 Z	60	50	69.1	129	78	50	ISO 7388-1	–	–
	DRIVING25X26	Driving block 25 x 26							> Page 161	
	M12X25	Screw							> Page 160	
Accessories	M16X50	Screw M16X50							> Page 160	

The accessories shown here must be used for all sizes!

Accessories	KBSK50-69872A	retention knob with through-hole	> Page 162
	KBSK50-69872B	retention knob without through-hole	> Page 152

Note: To use the Pokolm shell-type adapter, the base arbors must be fitted with 4 threaded bores! This must be included in the order, and is implemented by additionally ordering the bores under the item number: 4XGEB0-AUF

2/2

SK 50 ISO 7388-1 (formerly DIN 69871 AD)

for shell-type milling cutters (vibration-dampened)

New



Characteristics:

-
-
- ISO 7388-1**
- G 6,3 8.000**
-

for shell-type milling cutters	Order no.	d ₁	l ₃	A	d ₃	d ₄	d ₂	DIN / shape	l ₂	l ₁
--------------------------------	-----------	----------------	----------------	---	----------------	----------------	----------------	-------------	----------------	----------------

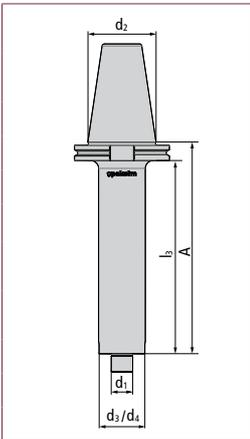

Bore diam. 16 mm	A200 16 710 VD	16	180.9	200	38	38	50	ISO 7388-1	-	-
	A300 16 710 VD	16	280.9	300	38	38	50	ISO 7388-1	-	-
Accessories	DRIVING8X8	Driving block 8 x 8							> Page 161	
	M3X10	Screw for driving block 8 x 8							> Page 160	
	M8X30	Screw M8X30							> Page 161	

Bore diam. 22 mm	A200 22 710 VD	22	180.9	200	48	48	50	ISO 7388-1	-	-
	A300 22 710 VD	22	280.9	300	48	48	50	ISO 7388-1	-	-
Accessories	DRIVING10X8	Driving block 10 x 8							> Page 161	
	M4X10	Screw for driving block 10 x 8							> Page 160	
	M10X35	Screw M10X35							> Page 161	

The accessories shown here must be used for all sizes!	Accessories	KMR-63A	Coolant supply tube for HSK tooling	> Page 162
		WRENCHHSK63	Wrench for coolant tubes	> Page 162

Characteristics:



for shell-type milling cutters	Order no.	d_1	l_3	A	d_3	d_4	d_2	DIN / shape	l_2	l_1
--------------------------------	-----------	-------	-------	---	-------	-------	-------	-------------	-------	-------

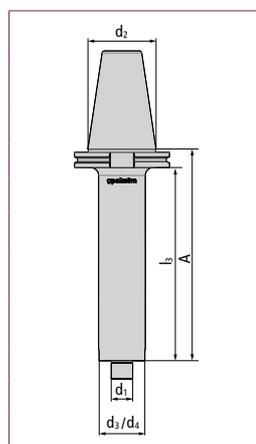

Bore diam. 27 mm	A200 27 710 VD	27	180.9	200	58	58	50	ISO 7388-1	–	–
	A300 27 710 VD	27	280.9	300	58	58	50	ISO 7388-1	–	–
Accessories	DRIVING12X8	Driving block 12 x 8							> Page 161	
	M5X12	Screw for driving block 12 x 8							> Page 160	
	M12X35	Screw M12X35							> Page 161	

The accessories shown here must be used for all sizes!	Accessories	KMR-63A	Coolant supply tube for HSK tooling	> Page 162
		WRENCHHSK63	Wrench for coolant tubes	> Page 162

<2/2

SK 50 ISO 7388-1 (formerly DIN 69871 AD)

Drill chucks

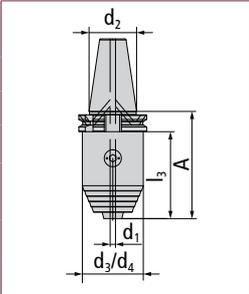

Characteristics:    **G 6,3**
25.000 **ISO**
7388-1

Drill chucks	Order no.	d ₁	l ₃	A	d ₃	d ₄	d ₂	DIN / shape	l ₂	l ₁	
	Diam. 0.5 to 13 mm	BF 0.5-13 710 IC	13	93	112.1	50	50	50	ISO 7388-1	–	–
	Accessories	BF13DS06	Gasket 1306							> Page 163	
		BF13DS13	Gasket 1313							> Page 163	
	Diam. 2.5 to 16 mm	BF 2.5-16 710 IC	16	98	117.1	57	57	50	ISO 7388-1	–	–
Accessories	BF16DS06	Gasket 1606							> Page 163		
	BF16DS16	Gasket 1616							> Page 163		
The accessories shown here must be used for all sizes!	Accessories	KBSK50-69872A	retention knob with through-hole							> Page 162	
		KBSK50-69872B	retention knob without through-hole							> Page 162	
		HEXA 6T	HEXA 6T							> Page 161	
		BF13MW	Wrench 13/16							> Page 163	

Scope of delivery includes wrench and gasket

SK 50 ISO 7388-1 (formerly DIN 69871 AD)

for Morse taper shanks



Characteristics:



G 6,3
12.000

ISO
7388-1

for Morse taper shanks	Order no.	d_1	l_3	A	d_3	d_4	d_2	DIN / shape	l_2	l_1
------------------------	-----------	-------	-------	---	-------	-------	-------	-------------	-------	-------

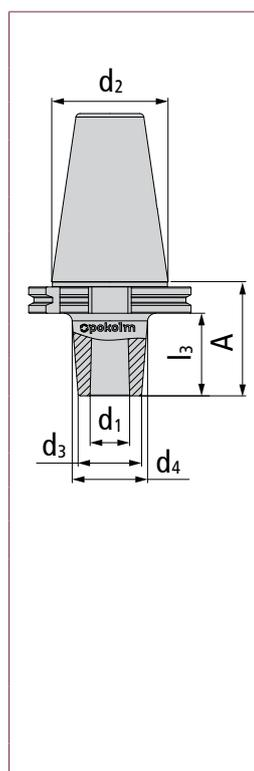

MK 2	40 2 710	2	40	69.1	30	36	50	ISO 7388-1	–	–
Accessories	M10X40		Screw for MK reduction sleeve					> Page 160		
MK 2	90 2 710	2	90	109.1	30	46	50	ISO 7388-1	–	–
Accessories	M10X90		Screw for MK reduction sleeve					> Page 160		
MK 3	50 3 710	3	50	69.1	38	46	50	ISO 7388-1	–	–
Accessories	M12X40		Screw for MK reduction sleeve					> Page 160		
MK 3	100 3 710	3	100	119.1	38	56	50	ISO 7388-1	–	–
Accessories	M12X90		Screw for MK reduction sleeve					> Page 160		
	Z 00104		Setscrew					> Page 160		
MK 3	150 3 710	3	150	169.1	38	62	50	ISO 7388-1	–	–
Accessories	M12X135		Screw for MK reduction sleeve					> Page 160		
MK 3	200 3 710	3	200	219.1	38	70	50	ISO 7388-1	–	–
Accessories	M12X185		Screw for MK reduction sleeve					> Page 156		

The accessories shown here must be used for all sizes!

Accessories	KBSK50-69872A	retention knob with through-hole	> Page 160
	KBSK50-69872B	retention knob without through-hole	> Page 160
	ZGHM2414	Threaded bush, right-hand thread	> Page 163
	GWST-M5X8-914	Setscrew	> Page 160
	1003	Wrench for MK reduction sleeve	> Page 161

1/2 >

SK 50 ISO 7388-1 (formerly DIN 69871 AD)

for Morse taper shanks

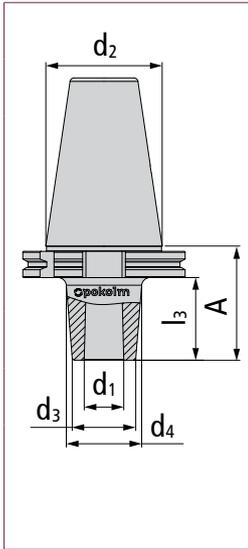
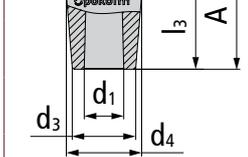

Characteristics:  **G 6,3**
12.000 **ISO**
7388-1

for Morse taper shanks	Order no.	d_1	l_3	A	d_3	d_4	d_2	DIN / shape	l_2	l_1	
	MK 4	80 4 710	4	80	99.1	44	56	ISO 7388-1	–	–	
		130 4 710	4	130	149.1	44	70	50	ISO 7388-1	–	–
		180 4 710	4	180	199.1	44	70	50	ISO 7388-1	–	–
Accessories	M16X50 IC	Screw for MK reduction sleeve							> Page 160		
	1004	Wrench for MK reduction sleeve							> Page 161		
	ZGHM2414L	Threaded bush, left-hand thread							> Page 163		
	MK 5	100 5 710	5	100	119.1	56	70	ISO 7388-1	–	–	
		150 5 710	5	150	169.1	56	70	50	ISO 7388-1	–	–
		200 5 710	5	200	219.1	56	75	50	ISO 7388-1	–	–
Accessories	M20X50	Screw for MK reduction sleeve							> Page 160		
	1005	Wrench for MK reduction sleeve							> Page 161		
The accessories shown here must be used for all sizes!	Accessories	KBSK50-69872A	retention knob with through-hole							> Page 162	
		KBSK50-69872B	retention knob without through-hole							> Page 162	
		Z 00104	Setscrew							> Page 160	
		ZGHM2414	Threaded bush, right-hand thread							> Page 163	

SK 50 ISO 7388-1 (formerly DIN 69871 AD)

Hydro expansion zero reach adapter



Characteristics:



Hydro expansion zero reach adapter	Order no.	d ₁	l ₃	A	d ₃	d ₄	d ₂	DIN / shape	l ₂	l ₁
------------------------------------	-----------	----------------	----------------	---	----------------	----------------	----------------	-------------	----------------	----------------

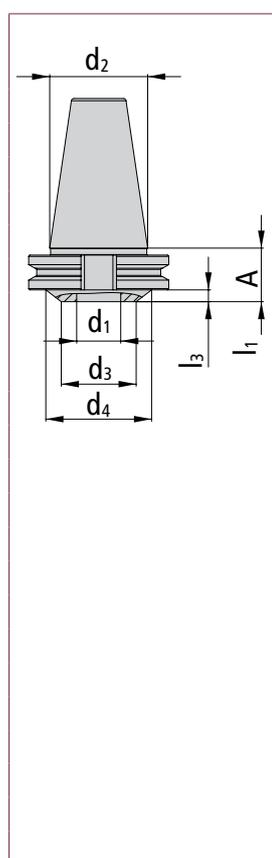

SK 50 Diameter 32 mm	15 32 710 HDF	32	11.4	30.5	44.5	70.5	50	ISO 7388-1	-	-
Accessories	KBSK50-69872A	retention knob with through-hole							> Page 162	
	KBSK50-69872B	retention knob without through-hole							> Page 162	
	PHK32 6	Reduction to 6 mm diam. (not coolant-tight)							> Page 165	
	PHK32 8	Reduction to 8 mm diam. (not coolant-tight)							> Page 165	
	PHK32 10	Reduction to 10 mm diam. (not coolant-tight)							> Page 165	
	PHK32 12	Reduction to 12 mm diam. (not coolant-tight)							> Page 165	
	PHK32 14	Reduction to 14 mm diam. (not coolant-tight)							> Page 165	
	PHK32 16	Reduction to 16 mm diam. (not coolant-tight)							> Page 165	
	PHK32 18	Reduction to 18 mm diam. (not coolant-tight)							> Page 165	
	PHK32 20	Reduction to 20 mm diam. (not coolant-tight)							> Page 165	
	PHK32 25	Reduction to 25 mm diam. (not coolant-tight)							> Page 165	
	PHK32 3 IC	Reduction to 3 mm diam. (not coolant-tight)							> Page 165	
	PHK32 4 IC	Reduction to 4 mm diam. (not coolant-tight)							> Page 165	
	PHK32 5 IC	Reduction to 5 mm diam. (not coolant-tight)							> Page 165	
	PHK32 6 IC	Reduction to 6 mm diam. (not coolant-tight)							> Page 165	
	PHK32 8 IC	Reduction to 8 mm diam. (not coolant-tight)							> Page 165	
	PHK32 10 IC	Reduction to 10 mm diam. (not coolant-tight)							> Page 165	
	PHK32 12 IC	Reduction to 12 mm diam. (not coolant-tight)							> Page 165	
	PHK32 14 IC	Reduction to 14 mm diam. (not coolant-tight)							> Page 165	
	PHK32 16 IC	Reduction to 16 mm diam. (not coolant-tight)							> Page 165	
	PHK32 18 IC	Reduction to 18 mm diam. (not coolant-tight)							> Page 165	
	PHK32 20 IC	Reduction to 20 mm diam. (not coolant-tight)							> Page 165	
	PHK32 25 IC	Reduction to 25 mm diam. (not coolant-tight)							> Page 165	

Scope of delivery includes Allen wrench

BT 50 ISO 7388-2 (formerly JIS B 6339 AD)

for threaded shank end mills

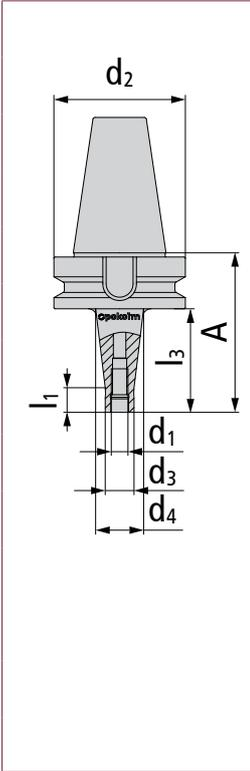

Characteristics:   **Form**
BT **G 6,3**
12.000 **ISO**
7388-2

for threaded shank end mills	Order no.	d_1	l_3	A	d_3	d_4	d_2	DIN / shape	l_2	l_1	
	M 12	50 12 714	M 12	50	88	21	30	50	ISO 7388-2	–	12
		100 12 714	M 12	100	138	21	38	50	ISO 7388-2	–	12
		150 12 714	M 12	150	188	21	52	50	ISO 7388-2	–	12
		200 12 714	M 12	200	238	21	58	50	ISO 7388-2	–	12
		250 12 714	M 12	250	288	21	63	50	ISO 7388-2	–	12
		300 12 714	M 12	300	338	21	68	50	ISO 7388-2	–	12
	M 16	50 16 714	M 16	50	88	29	34	50	ISO 7388-2	–	12
		100 16 714	M 16	100	138	29	40	50	ISO 7388-2	–	12
		150 16 714	M 16	150	188	29	48	50	ISO 7388-2	–	12
		200 16 714	M 16	200	238	29	58	50	ISO 7388-2	–	12
		250 16 714	M 16	250	288	29	62	50	ISO 7388-2	–	12
		300 16 714	M 16	300	338	29	68	50	ISO 7388-2	–	12
360 16 714		M 16	360	398	29	68	50	ISO 7388-2	–	12	

BT 50 ISO 7388-2 (formerly JIS B 6339 AD)

for shrinking



Characteristics:



for shrinking	Order no.	d ₁	l ₃	A	d ₃	d ₄	d ₂	DIN / shape	l ₂	l ₁	
	Diameter 6 mm	50 06 714 S	6	50	88	12	17	50	ISO 7388-2	–	7.8
		100 06 714 S	6	100	138	12	21.7	50	ISO 7388-2	–	7.8
		150 06 714 S	6	150	188	12	27	50	ISO 7388-2	–	7.8
		200 06 714 S	6	200	238	12	32	50	ISO 7388-2	–	7.8
	Diameter 8 mm	50 08 714 S	8	50	88	16	21	50	ISO 7388-2	–	7.8
		100 08 714 S	8	100	138	16	26	50	ISO 7388-2	–	7.8
		150 08 714 S	8	150	188	16	30.9	50	ISO 7388-2	–	7.8
		200 08 714 S	8	200	238	16	36	50	ISO 7388-2	–	7.8
	Diameter 10 mm	50 10 714 S	10	50	88	20	25	50	ISO 7388-2	–	7.8
		100 10 714 S	10	100	138	20	30	50	ISO 7388-2	–	7.8
		150 10 714 S	10	150	188	20	35	50	ISO 7388-2	–	7.8
		200 10 714 S	10	200	238	20	40	50	ISO 7388-2	–	7.8
Diameter 12 mm	50 12 714 S	12	50	88	24	28.4	50	ISO 7388-2	–	7.8	
	100 12 714 S	12	100	138	24	33.7	50	ISO 7388-2	–	7.8	
	150 12 714 S	12	150	188	24	39	50	ISO 7388-2	–	7.8	
	200 12 714 S	12	200	238	24	44	50	ISO 7388-2	–	7.8	

1/2>

BT 50 ISO 7388-2 (formerly JIS B 6339 AD)

for shrinking

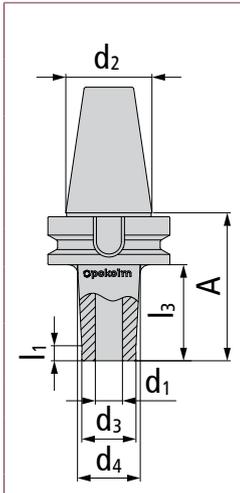

Characteristics:   **HSC** **Form BT** **G 6,3 12.000** **ISO 7388-2**

for shrinking	Order no.	d_1	l_3	A	d_3	d_4	d_2	DIN / shape	l_2	l_1	
	Diameter 16 mm	50 16 714 S	16	50	88	32	36.4	50	ISO 7388-2	-	7.8
		100 16 714 S	16	100	138	32	41.7	50	ISO 7388-2	-	7.8
		150 16 714 S	16	150	188	32	46.9	50	ISO 7388-2	-	7.8
		200 16 714 S	16	200	238	32	52	50	ISO 7388-2	-	7.8
	Diameter 20 mm	50 20 714 S	20	50	88	40	44.4	50	ISO 7388-2	-	7.8
		100 20 714 S	20	100	138	40	50	50	ISO 7388-2	-	7.8
	Diameter 25 mm	60 25 714 S	25	60	98	46	46	50	ISO 7388-2	-	-
		100 25 714 S	25	100	138	46	56	50	ISO 7388-2	-	7.8
	Diameter 32 mm	60 32 714 S	32	60	98	44	53	50	ISO 7388-2	-	-

BT 50 ISO 7388-2 (formerly JIS B 6339 AD)

for shrinking | zero reach adapters



Characteristics:

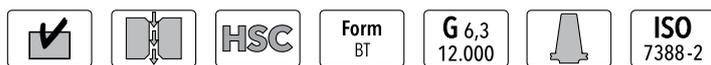

for shrinking zero reach adapters	Order no.	d_1	l_3	A	d_3	d_4	d_2	DIN / shape	l_2	l_1
-------------------------------------	-----------	-------	-------	---	-------	-------	-------	-------------	-------	-------

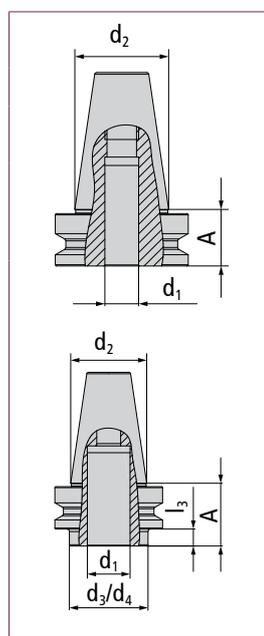

Diameter 20 mm	00 20 714 S	20	0	38	-	-	50	ISO 7388-2	-	-
Diameter 25 mm	00 25 714 S	25	0	38	-	-	50	ISO 7388-2	-	-
Diameter 32 mm	00 32 714 S	32	0	38	-	-	50	ISO 7388-2	-	-

Zero reach arbors cannot be ordered separately. They are shrunk at the factory with the corresponding solid carbide or dense antivibration material adapter (Please indicate the required adapter when placing your order!) and delivered ready for use. Relevant items are available in the section "Adapters, extensions and collet chucks" starting on page 26.

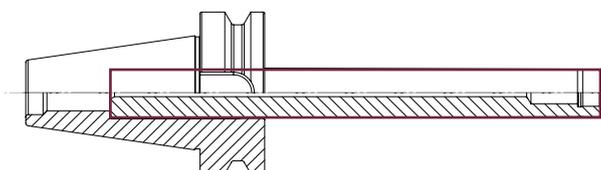

BT 50 ISO 7388-2 (formerly JIS B 6339 AD)

for shell-type milling cutters



Characteristics:

-
-
- Form**
BT
- G** 6,3
12.000
- ISO**
7388-2

for shell-type milling cutters		Order no.	d_1	l_3	A	d_3	d_4	d_2	DIN / shape	l_2	l_1
Bore diam. 16 mm	50 16 714 Z	16	50	88	38	42	50	ISO 7388-2	–	7.8	
	100 16 714 Z	16	100	138	38	50	50	ISO 7388-2	–	7.8	
	150 16 714 Z	16	150	188	38	50	50	ISO 7388-2	–	7.8	
Accessories	DRIVING8X8	Driving block 8 x 8							> Page 161		
	M3X10	Screw for driving block 8 x 8							> Page 161		
	M8X30	Screw M8x30							> Page 161		
Bore diam. 22 mm	50 22 714.01	22	50	88	48	48	50	ISO 7388-2	–	7.8	
	100 22 714	22	100	138	48	50	50	ISO 7388-2	–	7.8	
	150 22 714	22	150	188	48	62	50	ISO 7388-2	–	7.8	
	200 22 714	22	200	238	48	78	50	ISO 7388-2	–	7.8	
Accessories	DRIVING10X8	Driving block 10 x 8							> Page 161		
	M4X10	Screw for driving block 10 x 8							> Page 160		
	M10X35	Screw M10X35							> Page 161		
	4XGEB0-AUF	Threaded bores for adapter							> Page 164		
Bore diam. 27 mm	50 27 714	27	50	88	62	62	50	ISO 7388-2	–	7.8	
	100 27 714	27	100	138	62	70	50	ISO 7388-2	–	7.8	
	150 27 714	27	150	188	62	76	50	ISO 7388-2	–	7.8	
	200 27 714	27	200	238	62	76	50	ISO 7388-2	–	7.8	
Accessories	DRIVING12X12/2	Driving block 12 x 12							> Page 161		
	M5X12	Screw for driving block 12 x 8							> Page 160		
	M12X35	Screw M12X35							> Page 161		
	4XGEB0-AUF	Threaded bores for adapter							> Page 164		
Bore diam. 32 mm	50 32 714	32	50	88	95	78	50	ISO 7388-2	–	7.8	
	100 32 714	32	100	138	95	78	50	ISO 7388-2	–	7.8	
	150 32 714	32	150	188	95	78	50	ISO 7388-2	–	7.8	
	200 32 714	32	200	238	95	78	50	ISO 7388-2	–	7.8	
Accessories	DRIVING14X14	Driving block 14 x 14							> Page 161		
	M5X16	Screw for driving block 12 x 12 and 14 x 14							> Page 160		
	M16X26	Screw M16X26							> Page 161		

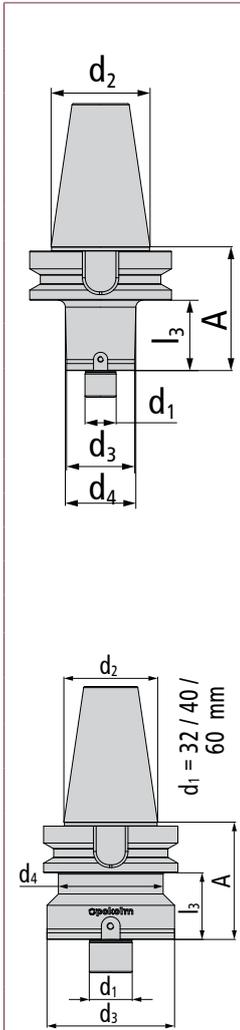

Characteristics:



Form
BT

G 6,3
12.000

ISO
7388-2

for shell-type milling cutters	Order no.	d ₁	l ₃	A	d ₃	d ₄	d ₂	DIN / shape	l ₂	l ₁		
For figures, see table at left	Bore diam. 40 mm	50 40 714 Z	40	50	88	100	78	50	ISO 7388-2	–	–	
	Accessories	M20X30	Screw M20X30						> Page 161			
	Bore diam. 60 mm	50 60 714 Z*	60	50	88	129	78	50	ISO 7388-2	–	–	
	Accessories	DRIVING25X26	Driving block 25 x 26						> Page 161			
		M12X25	Screw						> Page 160			
		M16X50	Screw M16X50						> Page 160			

Note: To use the Pokolm shell-type adapter, the base arbors must be fitted with 4 threaded bores! This must be included in the order, and is implemented by additionally ordering the bores under the item number: 4XGEBO-AUF <2/2

* no internal coolant supply available

BT 50 ISO 7388-2 (formerly JIS B 6339 AD)

Hydro expansion zero reach adapter



Characteristics:

-
-
-
- HSC**
- G 2,5**
25.000
- ISO**
7388-2

Hydro expansion zero reach adapter	Order no.	d ₁	l ₃	A	d ₃	d ₄	d ₂	DIN / shape	l ₂	l ₁
------------------------------------	-----------	----------------	----------------	---	----------------	----------------	----------------	-------------	----------------	----------------

	BT 50 Diameter 32 mm 15 32 714 HDF	32	11.4	49.4	44.5	70.5	50	ISO 7388-2	–	–	
	Accessories										
	PHK32 6	Reduction to 6 mm diam. (not coolant-tight)								> Page 165	
	PHK32 8	Reduction to 8 mm diam. (not coolant-tight)								> Page 165	
	PHK32 10	Reduction to 10 mm diam. (not coolant-tight)								> Page 165	
	PHK32 12	Reduction to 12 mm diam. (not coolant-tight)								> Page 165	
	PHK32 14	Reduction to 14 mm diam. (not coolant-tight)								> Page 165	
	PHK32 16	Reduction to 16 mm diam. (not coolant-tight)								> Page 165	
	PHK32 20	Reduction to 20 mm diam. (not coolant-tight)								> Page 165	
	PHK32 25	Reduction to 25 mm diam. (not coolant-tight)								> Page 165	
	PHK32 3 IC	Reduction to 3 mm diam. (not coolant-tight)								> Page 165	
	PHK32 4 IC	Reduction to 4 mm diam. (not coolant-tight)								> Page 165	
	PHK32 5 IC	Reduction to 5 mm diam. (not coolant-tight)								> Page 165	
	PHK32 6 IC	Reduction to 6 mm diam. (not coolant-tight)								> Page 165	
	PHK32 8 IC	Reduction to 8 mm diam. (not coolant-tight)								> Page 165	
	PHK32 10 IC	Reduction 10 mm diam. (not coolant-tight)								> Page 165	
	PHK32 12 IC	Reduction 12 mm diam. (not coolant-tight)								> Page 165	
	PHK32 14 IC	Reduction 14 mm diam. (not coolant-tight)								> Page 165	
	PHK32 16 IC	Reduction 16 mm diam. (not coolant-tight)								> Page 165	
	PHK32 18 IC	Reduction 18 mm diam. (not coolant-tight)								> Page 165	
PHK32 20 IC	Reduction 20 mm diam. (not coolant-tight)								> Page 165		
PHK32 25 IC	Reduction 15 mm diam. (not coolant-tight)								> Page 165		

Scope of delivery includes Allen wrench



PRODUCT VARIETY WITH THE HIGHEST PRECISION



Flat contact surface

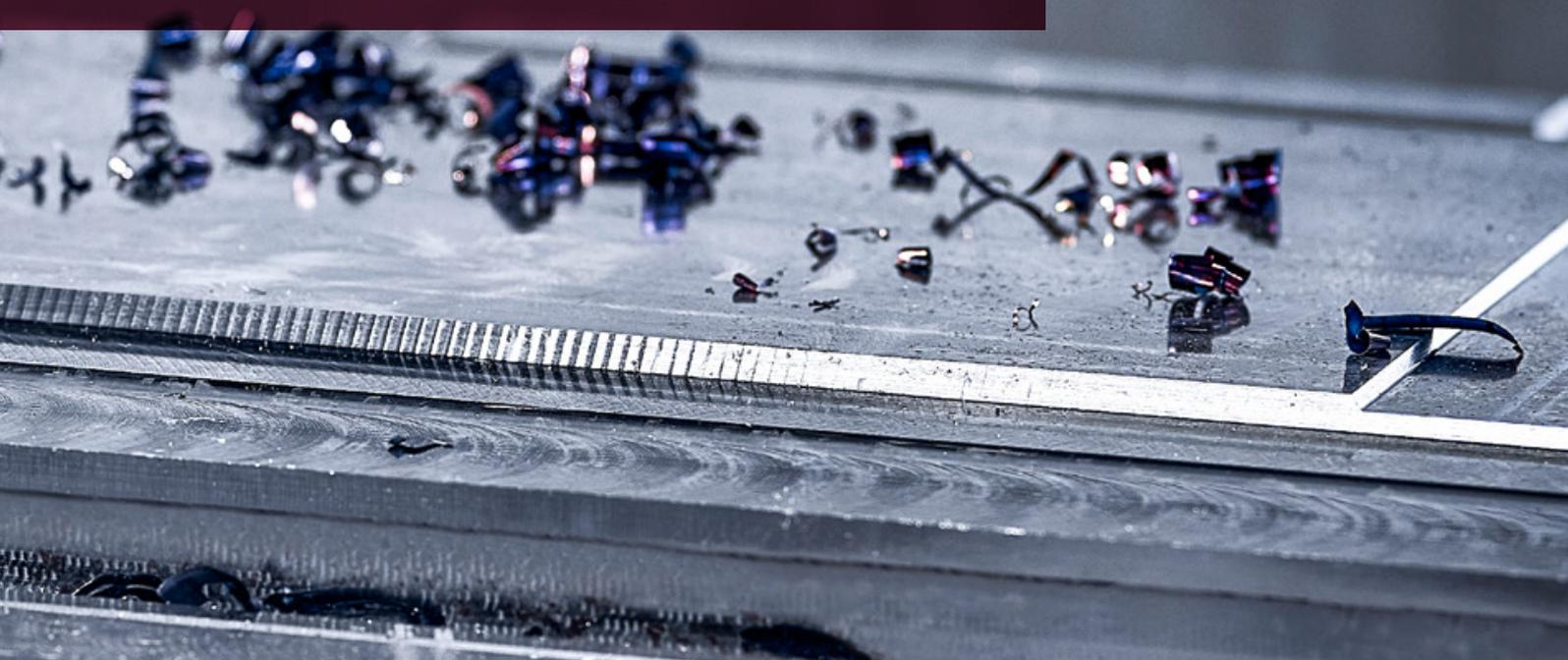

At a glance

	Page
SK 50 for shell-type milling cutters	154
SK 50 / HSK 100 – centering arbor / adapter	156

PRODUCT VARIETY WITH THE HIGHEST PRECISION



Pokolm flat contact surfaces

Features and advantages:

- For direct mounting on the machine spindle
- Mounting bore in accordance with DIN 1830 to attach to milling spindle heads according to DIN 2079
- Maximum stability and rigidity with long overhangs or difficult cutting tasks
- Arbors made of high temperature-resistant material
- Hardness 52 - 54 HRC

SK 50

for shell-type milling cutters



Characteristics: DIN 1830 DIN 2079

for shell-type milling cutters		Order no.	d_1	l_3^*	A	d_3	d_4	d_2	DIN / shape	l_2	l_1	
	Bore diam. 22 mm	200 22 740	22	200	233	48	78	50	Flat contact surface	–	38	
		250 22 740	22	250	283	48	82	50	Flat contact surface	–	38	
		300 22 740	22	300	333	48	86	50	Flat contact surface	–	38	
		350 22 740	22	350	383	48	90	50	Flat contact surface	–	38	
		400 22 740	22	400	433	48	95	50	Flat contact surface	–	38	
Accessories	DRIVING10X8	Driving block 10 x 8								> Page 161		
	M4X10	Screw for driving block 10 x 8								> Page 160		
	M10X35	Screw M10X35								> Page 161		
	4XGEBO-AUF	Threaded bores for adapter								> Page 164		
	Bore diam. 27 mm	200 27 740	27	200	233	62	78	50	Flat contact surface	–	38	
		250 27 740	27	250	283	62	82	50	Flat contact surface	–	38	
		300 27 740	27	300	333	62	86	50	Flat contact surface	–	38	
		350 27 740	27	350	383	62	90	50	Flat contact surface	–	38	
		400 27 740	27	400	433	62	95	50	Flat contact surface	–	38	
Accessories	DRIVING12X12/2	Driving block 12 x 12								> Page 161		
	M5X16	Screw for driving block 12 x 12								> Page 160		
	M12X35	Screw M12X35								> Page 161		
	4XGEBO-AUF	Threaded bores for adapter								> Page 164		
	Bore diam. 32 mm	150 32 740	32	150	183	85	98	50	Flat contact surface	–	38	
		200 32 740	32	200	233	85	98	50	Flat contact surface	–	38	
		250 32 740	32	250	283	90	105	50	Flat contact surface	–	38	
		300 32 740	32	300	333	90	110	50	Flat contact surface	–	38	
		350 32 740	32	350	383	90	117	50	Flat contact surface	–	38	
		400 32 740	32	400	433	90	124	50	Flat contact surface	–	38	
Accessories	DRIVING14X14	Driving block 14 x 14								> Page 161		
	M5X16	Screw for driving block 14 x 14								> Page 160		
	M16X26	Screw M16X26								> Page 161		
The accessories shown here must be used for all sizes!	Accessories	Z 00038	Retaining bolt flat contact surface								> Page 163	
		4XGEBO-AUF	Threaded bores								> Page 164	

*Dimension minus screw head height

Characteristics:



for shell-type milling cutters	Order no.	d_1	l_3	A	d_3	d_4	d_2	DIN / shape	l_2	l_1
--------------------------------	-----------	-------	-------	---	-------	-------	-------	-------------	-------	-------

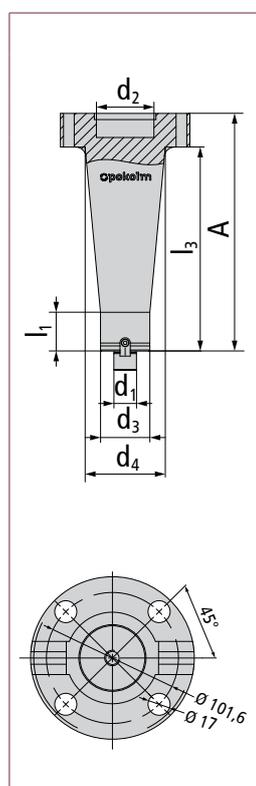

Bore diam. 40 mm	100 40 740	40	100	133	100	124	50	Flat contact surface	-	38
	150 40 740	40	150	183	100	124	50	Flat contact surface	-	38
	200 40 740	40	200	233	100	124	50	Flat contact surface	-	38
Accessories	DRIVING16X16	Driving block 16 x 16							> Page 161	
	M6X16	Screw for driving block 16 x 16							> Page 160	
	M20X30	Screw M20X30							> Page 161	

The accessories shown here must be used for all sizes!	Accessories	Z 00038	Retaining bolt flat contact surface	> Page 159
--	--------------------	---------	-------------------------------------	------------

Note: To use the Pokolm shell-type adapter, the base arbors must be fitted with 4 threaded bores! This must be included in the order, and is implemented by additionally ordering the bores under the item number: 4XGEB0-AUF <2/2

SK 50 / HSK 100

Centering arbor | adapter (HSK 100 for flat contact surfaces)



Characteristics:



Centering arbor adapter	Order no.	d_1	l_3	A	d_3	d_4	d_2	DIN / shape	l_2	l_1
---------------------------	-----------	-------	-------	---	-------	-------	-------	-------------	-------	-------

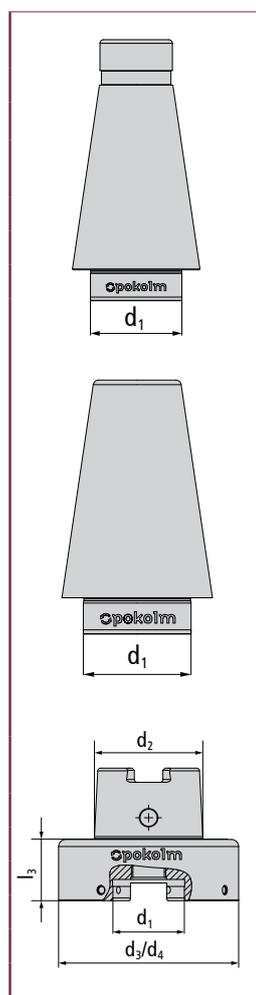

SK 50	50 742	50	–	–	–	–	50	DIN 2080	–	–
Accessories	Z 00038	Retaining bolt flat contact surface							> Page 163	
SK 50	50 743	50	–	–	–	–	50	ISO 7388-1	–	–
Accessories	KBSK50-69872A	retention knob with through-hole							> Page 162	
	KBSK50-69872B	retention knob without through-hole							> Page 162	
	Z 00038	Retaining bolt flat contact surface							> Page 163	

Scope of delivery includes retaining bolt Z 00038

HSK 100 Form A	40 740 A100	50	14.5	43.5	126	126	100	Form A	–	–
Accessories	DRIVING25X26	Driving block 25 x 26							> Page 161	
	M16X60	Screw for MK reduction sleeve							> Page 160	
	GWST-M6X10-914	Setscrew							> Page 160	
	M12X35	Screw M12X35							> Page 161	
	KMR-100A	Coolant supply tube for HSK tooling							> Page 162	
	WRENCHHSK100	Wrench for coolant tubes							> Page 162	



PRODUCT VARIETY IN THE HIGHEST QUALITY



Accessories

At a glance

		Page
Cheese-head screws with hexagon socket	for driving blocks.....	160
	for MK reduction sleeve.....	160
	for shell-type and threaded adapters	160
Other screws and washers	Setscrew.....	160
	Cutter retaining bolts	161
Spacer	for arbors with tangs	161
Wrench	Collet chuck wrench.....	161
	Wrench for MK reduction sleeve	161
	Wrench for drill chuck	161
Tightning nuts, driving blocks	Tightning nuts.....	161
	Driving blocks.....	161
HSK accessories	Coolant supply tube	162
	Wrench for coolant supply tubes	162
Retention knobs	Retention knobs without seal ring grooves	162
	Retention knobs with seal ring grooves	162
CoolCap®	CoolCap® for water/emulsion	162
	CoolCap® for air/MMS	163
	CoolCap® application tool	163
	CoolCap® torque wrench.....	163
Threaded sleeves	Threaded sleeves	163
Drill chuck accessories	Gaskets	163
	Wrench	163
Retaining bolt	Retaining bolt flat contact surface	163
Threaded bores	163
PHK reductions	164

Sure to fit: high-quality original accessories.

If you choose high-quality milling tools from Pokolm, stay on the safe side and set high standards when choosing accessories.

Pokolm uses high-quality screws, screwdrivers, and accessories from leading manufacturers, optimally tailored to the performance capabilities of our products.

Pokolm original accessories

Accessories	Order no.	Designation	Dimensions			
-------------	-----------	-------------	------------	--	--	--

Cheese-head screws with hexagon socket for driving blocks						
	M12X25	Screw for driving block 12 x 25	M 12	L 25	DIN 912	–
	M6X16	Screw for driving block 16 x 16	M 6	L 16	DIN 912	–
	M5X12	Screw for driving block 12 x 8	M 5	L 12	DIN 912	–
	M4X10	Screw for driving block 10 x 8	M 4	L 10	DIN 912	–
	M3X10	Screw for driving block 8 x 8	M 3	L 10	DIN 912	–
	M5X16	Screw for driving block 12 x 12 and 14 x 14	M 5	L 16	DIN 912	–

Cheese-head screws with hexagon socket MK reduction sleeve						
	M10X40	Screw for MK reduction sleeve	M 10	L 40	DIN 912	–
	M10X45 IC	Screw for 100 MK2 AL A63 for 100 MK2 AL A63 with IC	M 10	L 45	–	with IC
	M10X90	Screw for MK reduction sleeve	M 10	L 90	DIN 912	–
	M12X40	Screw for MK reduction sleeve	M 12	L 40	DIN 912	–
	M12X50 IC	Screw for 120 MK3 AL A63	M 12	L 50	–	with IC
	M12X90	Screw for MK reduction sleeve	M 12	L 90	DIN 912	–
	M12X135	Screw for MK reduction sleeve	M 12	L 135	DIN 912	–
	M12X185	Screw for MK reduction sleeve	M 12	L 185	DIN 912	–
	M16X50	Screw for MK reduction sleeve	M 16	L 50	DIN 912	–
	M16X50 IC	Screw for MK reduction sleeve	M 16	L 50	DIN 912	with IC
	M16X60	Screw for MK reduction sleeve	M 16	L 60	DIN 912	–
	M20X50	Screw for MK reduction sleeve	M 20	L 50	DIN 912	–

Cheese-head screws with hexagon socket for shell-type and threaded adapters						
	M6X25	Cheese-head screw	M 6	L 25	DIN 912	12.9
	M6X55	Cheese-head screw	M 6	L 55	DIN 912	12.9
	M8X25	Cheese-head screw	M 8	L 25	DIN 912	12.9
	M8X55	Cheese-head screw	M 8	L 55	DIN 912	12.9

other screws and washers setscrew						
	M10X10	Straining screw	M 10	L 10	DIN 914	–
	M12X10	Straining screw	M 12	L 10	DIN 914	–
	M14X12	Straining screw	M 14	L 12	DIN 914	–
	M10X9 SR1 W	Straining screw	M 10	L 9	DIN 1835-2	–
	M12X10 SR1 W	Straining screw	M 12	L 10	DIN 1835-2	–
	M14X11 SR1 W	Straining screw	M 14	L 11	DIN 1835-2	–
	M16X10 SR1 W	Straining screw	M 16	L 10	DIN 1835-2	–
	GWST-M5X8-914	Setscrew	M 5	L 8	hexa. size 2.5	DIN 914
	GWST-M6X10-914	Setscrew	M 6	L 10	hexa. size 2.5	DIN 914
	Z 00104	Setscrew	M 5	L 7	hexa. size 2.5	hexa. size 2.5

Accessories	Order no.	Designation	Dimensions			
-------------	-----------	-------------	------------	--	--	--

Other screws and washers cutter retaining bolts						
	M3X10	Screw for driving block 8 x 8	M 3	L 10	DIN 912	–
	M8X30	Screw	M 8	L 30	DIN 912	10.9
	M10X35	Screw	M 10	L 35	DIN 912	10.9
	M12X35	Screw	M 12	L 35	DIN 912	10.9
	M16X26	Screw	M 16	L 26	DIN 6367	–
	M20X30	Screw	M 20	L 30	DIN 6367	–

Spacer						
	Z 00142	Spacer for arbors with tangs	Diam. 16	S = 1.5	Diam. 5	–

Wrench collet chuck wrench						
	16 501	Collet chuck wrench for ER 16 tightening nut	M 19x1	–	–	–
	20 501	Collet chuck wrench for ER 20 tightening nut	M 24x1	–	–	–

Wrench Wrench for MK reduction sleeve						
	1003	Wrench for MK reduction sleeve	MK 2	MK 3	–	–
	1004	Wrench for MK reduction sleeve	MK 4	–	–	–
	1005	Wrench for MK reduction sleeve	MK 5	–	–	–

Wrench Wrench for drill chuck						
	HEXA 4T	HEXA 4T	SW4	–	–	–
	NBUS 6T	HEXA 6T	SW6	–	–	–

Tightning nuts						
	ER16 001	Tightning nut ER 16	M 19 x 1	–	–	–
	ER20 001	Tightning nut	M 24 x 1	–	–	–

Driving blocks						
	NUTEN8X8	Driving block 8 x 8	B 8	H 8	L 12	–
	NUTEN10X8	Driving block 10 x 8	B 10	H 8	L 18	–
	NUTEN12X8	Driving block 12 x 8	B 12	H 8	L 20	–
	NUTEN12X12/2	Driving block 12 x 12	B 12	H 12	L 20	–
	NUTEN14X14	Driving block 14 x 14	B 14	H 14	L 24	–
	NUTEN16X16	Driving block 16 x 16	B 16	H 16	L 24	–
	NUTEN25X26	Driving block 25 x 26	B 25	H 25	L 26	–

Pokolm original accessories

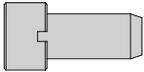
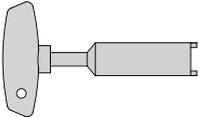
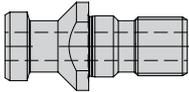
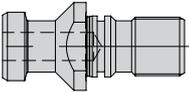
Accessories	Order no.	Designation	Dimensions			
HSK accessories coolant supply tubes						
	KMR-25	Coolant supply tube for HSK tooling	for HSK 25	Form A+ E	–	–
	KMR-32	Coolant supply tube for HSK tooling	for HSK 32	Form A+ E	–	–
	KMR-40A	Coolant supply tube for HSK tooling	for HSK 40	Form A+ E	–	–
	KMR-50A	Coolant supply tube for HSK tooling	for HSK 50	Form A+ E	–	–
	KMR-63A	Coolant supply tube for HSK tooling	for HSK 63	Form A+ E	–	–
	KMR-100A	Coolant supply tube for HSK tooling	for HSK 100	Form A	–	–
HSK accessories Wrench for coolant supply tubes						
	WRENCHHSK25	Wrench for coolant tubes	HSK 25	–	–	–
	WRENCHHSK32	Wrench for coolant tubes	HSK 32	–	–	–
	WRENCHHSK40	Wrench for coolant tubes	HSK 40	–	–	–
	WRENCHHSK50	Wrench for coolant tubes	HSK 50	–	–	–
	WRENCHHSK63	Wrench for coolant tubes	HSK 60	–	–	–
	WRENCHHSK100	Wrench for coolant tubes	HSK 100	–	–	–
Retention knobs without seal ring groove						
	KBSK30-69872A	Retention knob with through-hole	SK 30	DIN 69872 A	without seal ring groove	–
	KBSK40-69872A	Retention knob with through-hole	SK 40	DIN 69872 A	without seal ring groove	–
	KBSK50-69872A	Retention knob with through-hole	SK 50	DIN 69872 A	without seal ring groove	–
Retention knobs with seal ring groove						
	KBSK30-69872B	Retention knob without through-hole	SK 30	DIN 69872 A	with seal ring groove	–
	KBSK40-69872B	Retention knob without through-hole	SK 40	DIN 69872 A	with seal ring groove	–
	KBSK50-69872B	Retention knob without through-hole	SK 50	DIN 69872 A	with seal ring groove	–
CoolCap® for water/emulsion						
	SR1 S04 SW15	CoolCap® screw-on cap diam. 4 for water cooling			–	–
	SR1 S06 SW17	CoolCap® screw-on cap diam. 6 for water cooling			–	–
	SR1 S08 SW21	CoolCap® screw-on cap diam. 8 for water cooling			–	–
	SR1 S10 SW22	CoolCap® screw-on cap diam. 10 for water cooling			–	–
	SR1 S12 SW27	CoolCap® screw-on cap diam. 12 for water cooling			–	–
	SR1 S16 SW32	CoolCap® screw-on cap diam. 16 for water cooling			–	–
	SR1 S20 SW36	CoolCap® screw-on cap diam. 20 for water cooling			–	–

Accessories	Order no.	Designation	Dimensions		
-------------	-----------	-------------	------------	--	--

CoolCap®					
CoolCap® for air/ MMS					
	SR1 A04 SW17	CoolCap® screw-on cap diam. 4 for air cooling and MMS	–	–	–
	SR1 A06 SW17	CoolCap® screw-on cap diam. 6 for air cooling and MMS	–	–	–
	SR1 A08 SW21	CoolCap® screw-on cap diam. 8 for air cooling and MMS	–	–	–
	SR1 A10 SW22	CoolCap® screw-on cap diam. 10 for air cooling and MMS	–	–	–
	SR1 A12 SW27	CoolCap® screw-on cap diam. 12 for air cooling and MMS	–	–	–
	SR1 A16 SW32	CoolCap® screw-on cap diam. 16 for air cooling and MMS	–	–	–
	SR1 A20 SW36	CoolCap® screw-on cap diam. 20 for air cooling and MMS	–	–	–

CoolCap® CoolCap® application tool					
	SR1 ZSW 002	CoolCap®-application tool SR1 universal wrench	–	–	–

CoolCap® CoolCap® torque wrench					
	DMS 3/8 8-60 NM	Torque wrench 3/8"	for SR1 ZSW 002	–	–

Threaded bushes					
	ZGHM2414	Threaded bush, right-hand thread	M 24	–	–
	ZGHM2414L	Threaded bush, left-hand thread	M 24	–	–
	ZGHM3316L	Threaded bush, left-hand thread	M 33	–	–

Drill chuck accessories gaskets					
	BF08DS04	Gasket 0804	–	–	–
	BF08DS08	Gasket 0808	–	–	–
	BF13DS06	Gasket 1306	–	–	–
	BF13DS13	Gasket 1313	–	–	–
	BF16DS06	Gasket 1606	–	–	–
	BF16DS16	Gasket 0804	–	–	–

Drill chuck accessories wrench					
	BF08MW	Wrench 08	–	–	–
	BF13MW	Wrench 13/16	–	–	–

Retaining bolt flat contact surface					
	Z 00038	Retaining bolt flat contact surface	M12	–	–

Pokolm original accessories

Accessories	Order no.	Designation	Dimensions
-------------	-----------	-------------	------------

Threaded bores			
	4XGEBO-AUF	Threaded bores for adapter	–

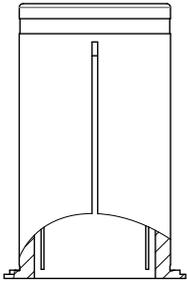
PHK reductions			
	PHK20 6	Reduction to 6 mm diam. (not coolant-tight)	–
	PHK20 8	Reduction to 8 mm diam. (not coolant-tight)	–
	PHK20 10	Reduction to 10 mm diam. (not coolant-tight)	–
	PHK20 12	Reduction to 12 mm diam. (not coolant-tight)	–
	PHK20 14	Reduction to 14 mm diam. (not coolant-tight)	–
	PHK20 16	Reduction to 16 mm diam. (not coolant-tight)	–
	PHK20 3 IC	Reduction to 3 mm diam. (not coolant-tight)	–
	PHK20 4 IC	Reduction to 4 mm diam. (not coolant-tight)	–
	PHK20 5 IC	Reduction to 5 mm diam. (not coolant-tight)	–
	PHK20 6 IC	Reduction to 6 mm diam. (not coolant-tight)	–
	PHK20 8 IC	Reduction to 8 mm diam. (not coolant-tight)	–
	PHK20 10 IC	Reduction to 10 mm diam. (not coolant-tight)	–
	PHK20 12 IC	Reduction to 12 mm diam. (not coolant-tight)	–
	PHK20 14 IC	Reduction to 14 mm diam. (not coolant-tight)	–
PHK20 16 IC	Reduction to 16 mm diam. (not coolant-tight)	–	

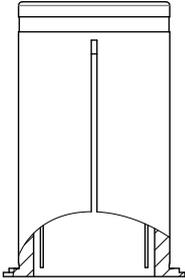
Accessories	Order no.	Designation	Dimensions
PHK reductions			
	PHK32 6	Reduction to 6 mm diam. (not coolant-tight)	–
	PHK32 8	Reduction to 8 mm diam. (not coolant-tight)	–
	PHK32 10	Reduction to 10 mm diam. (not coolant-tight)	–
	PHK32 12	Reduction to 12 mm diam. (not coolant-tight)	–
	PHK32 14	Reduction to 14 mm diam. (not coolant-tight)	–
	PHK32 16	Reduction to 16 mm diam. (not coolant-tight)	–
	PHK32 18	Reduction to 18 mm diam. (not coolant-tight)	–
	PHK32 20	Reduction to 20 mm diam. (not coolant-tight)	–
	PHK32 25	Reduction to 25 mm diam. (not coolant-tight)	–
	PHK32 3 IC	Reduction to 3 mm diam. (not coolant-tight)	–
	PHK32 4 IC	Reduction to 4 mm diam. (not coolant-tight)	–
	PHK32 5 IC	Reduction to 5 mm diam. (not coolant-tight)	–
	PHK32 6 IC	Reduction to 6 mm diam. (not coolant-tight)	–
	PHK32 8 IC	Reduction to 8 mm diam. (not coolant-tight)	–
	PHK3210 IC	Reduction 10 mm diam. (not coolant-tight)	–
	PHK32 12 IC	Reduction 12 mm diam. (not coolant-tight)	–
	PHK32 14 IC	Reduction 14 mm diam. (not coolant-tight)	–
	PHK32 16 IC	Reduction 16 mm diam. (not coolant-tight)	–
	PHK32 18 IC	Reduction 18 mm diam. (not coolant-tight)	–
	PHK32 20 IC	Reduction 20 mm diam. (not coolant-tight)	–
PHK32 25 IC	Reduction 25 mm diam. (not coolant-tight)	–	

PRODUCT VARIETY WITH THE HIGHEST PRECISION

Order / request forms



Order / request form

Custom design milling arbors

Please copy first, then fill out!

Inquiry no. / order no.: _____ Date: _____

Company: _____

Address: _____

Department: _____ Administrator: _____

Telephone: _____ Fax: _____ E-mail: _____

Arbor for threaded shank end mills

<input type="text"/>	Desired delivery date	<input type="text"/>	Bracket	Surface treatment	<input type="text"/>	Nickel	<input type="text"/>	Burnished
<input type="text"/>	HRC	<input type="text"/>	Piece	<input type="text"/>	SK	(Size)	<input type="text"/>	(DIN)
<input type="text"/>	Required balancing grade	<input type="text"/>	Made of material	<input type="text"/>	HSK	(Size)	<input type="text"/>	(Form)
				Coolant feed	<input type="text"/>	Central bore		
				<input type="text"/>	Through the arbor collar			

Note: Please fill out $d_3 = d_4$ for cylindrical design. 4 calendar weeks shorter delivery time for burnished surface.

Back office: _____ Sales representative: _____

Order / request form

Custom design milling arbors

Please copy first, then fill out!

Inquiry no. / order no.: _____ Date: _____

Company: _____

Address: _____

Department: _____ Administrator: _____

Telephone: _____ Fax: _____ E-mail: _____

Arbor for shell-type milling cutters

<input type="text"/>	Desired delivery date	<input type="text"/>	Bracket	Surface treatment	<input type="text"/>	Nickel	<input type="text"/>	Burnished		
<input type="text"/>	d_4	<input type="text"/>	d_3	<input type="text"/>	d_1	SK	<input type="text"/>	(Size)	<input type="text"/>	(DIN)
<input type="text"/>	HRC	<input type="text"/>	l_1	<input type="text"/>	r	HSK	<input type="text"/>	(Size)	<input type="text"/>	(Form)
<input type="text"/>	Piece	<input type="text"/>	l_3	<input type="text"/>	Made of material	Coolant feed	<input type="text"/>	Central bore	<input type="text"/>	Through the arbor collar
<input type="text"/>	Required balancing grade	<input type="text"/>	c	<input type="text"/>						

Note: Please fill out $d_3 = d_4$ for cylindrical design. 4 calendar weeks shorter delivery time for burnished surface.

Back office: _____ Sales representative: _____

Order / request form

Custom design milling arbors

Please copy first, then fill out!

Inquiry no. / order no.: _____ Date: _____

Company: _____

Address: _____

Department: _____ Administrator: _____

Telephone: _____ Fax: _____ E-mail: _____

Shrink fit arbor

<input type="text"/>	Desired delivery date	<input type="text"/>	Bracket	Surface treatment	<input type="text"/>	Nickel	<input type="text"/>	Burnished	
<input type="text"/>	HRC	<input type="text"/>	Piece	<input type="text"/>	SK	<input type="text"/>	(Size)	<input type="text"/>	(DIN)
<input type="text"/>	Required balancing grade	<input type="text"/>	l_1	<input type="text"/>	HSK	<input type="text"/>	(Size)	<input type="text"/>	(Form)
<input type="text"/>		<input type="text"/>	l_3	<input type="text"/>	Coolant feed	<input type="text"/>	Central bore	<input type="text"/>	Through the arbor collar
<input type="text"/>		<input type="text"/>	r	<input type="text"/>	Made of material	<input type="text"/>		<input type="text"/>	

Note: Please fill out $d_3 = d_4$ for cylindrical design. 4 calendar weeks shorter delivery time for burnished surface.

Back office: _____ Sales representative: _____

Order/request form

Custom design adapters

Please copy first, then fill out!

Inquiry no. / order no.: _____ Date: _____

Company: _____

Address: _____

Department: _____ Administrator: _____

Telephone: _____ Fax: _____ E-mail: _____

Solid carbide and dense antivibration material extension for threaded shank end mills

Desired delivery date d_4

Piece with Weldon surface
 with internal coolant supply

Solid carbide adapters for Pokolm DuoPlug®

Desired delivery date d_4

Piece with internal coolant supply

MK adapters for threaded shank end mills

Desired delivery date d_4

Surface treatment
 Nickel Burnished

HRC MK with internal coolant supply

Material Piece with internal coolant supply

Note: Please fill out $d_3 = d_4$ for cylindrical design. 4 calendar weeks shorter delivery time for burnished surface.

Back office: _____ Sales representative: _____



PRODUCT VARIETY WITH THE HIGHEST PRECISION

Drehzahl : 60.000 min-1
Leistung : 11.300 Watt

Spindle systems /
shrink technology

Pokolm high-frequency spindles

Features and advantages

- Spindle powers from 0.8 kW to 13.5 kW
- Speeds from 5,000 1/min to 80,000 1/min
- Interfaces
- Improved surfaces and significant reduction in eroding work.
- Significantly shorter machining times.

Pokolm shrink grip technology

Features and advantages

- Extremely high concentricity
- The highest precision, with significantly longer tool lives
- Shrinking technology creates an optimal frictional connection between the tool and arbor, ensuring high torque transmission.
- The ability to work at maximum speed is the best prerequisite for achieving an ideal surface grade and avoiding expensive ultrafine machining processes.

High-frequency spindles

Modern spindle systems for effective milling performance.

Many milling machines – both newer machines and older models – have a relatively low maximum speed. A low maximum speed, of course, delivers advantages in roughing, but is the biggest brake on achieving effective feed rates. Low speeds likewise greatly restrict the advantages of modern CNC applications. The consequence are significantly longer machining times, and a loss of profitable capacity.

Pokolm offers impressive solutions for just this problem: modern spindle systems for effective milling results.



Better surfaces and significant time savings.

The advantages are impressive: higher cutting speeds and utilizing the maximum feed rate – even for the smallest cutters. For improved surfaces and significant reduction in eroding work. This results in significantly shorter machining times and full utilization of the advantages of CNC.

Get the maximum speed from your machines with Pokolm spindles and save time as a result.

Ask about our spindle service, including:

- Replacement parts
- Maintenance
- Repairs
- Swivel devices
- Inspection
- CNC machine connection

Get in touch with us!

Shrinking technology

First shrink, then mill

More and more users are switching to shrinking technology, thanks to the advantages it offers over common clamping methods. The biggest of these is extremely good concentricity, which guarantees the highest precision with significantly longer tool lives.

In addition, shrinking technology creates an optimal frictional connection between the tool and arbor, ensuring high torque transmission. And suitability for maximum speed is the best prerequisite for achieving an ideal surface grade thereby avoiding expensive ultrafine machining processes.

In comparison to traditional tool arbors, shrink fit arbors have a slimmer design, making it possible to use even the smallest tools at the greatest depths, something impossible with a collet chuck.

Pokolm offers a comprehensive range of shrinking technology products: a high-quality, well-engineered induction shrinking device, shrink fit arbors for all common machine connections, and the patented Pokolm DuoPlug® connection system.



More information on Pokolm DuoPlug® is available on the relevant catalog pages (see index).

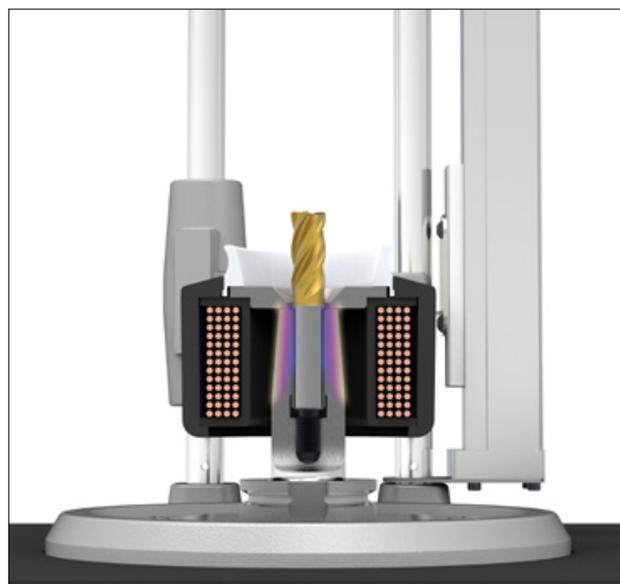

PRODUCT VARIETY WITH THE HIGHEST PRECISION

Assembly instructions



Assembly instructions

Coolant supply tubes for HSK Form A and Form E

To use adapters with interior cooling, they must be fitted with a coolant supply tube. For assembly, please follow the instructions. The required accessories are indicated for each adapter.

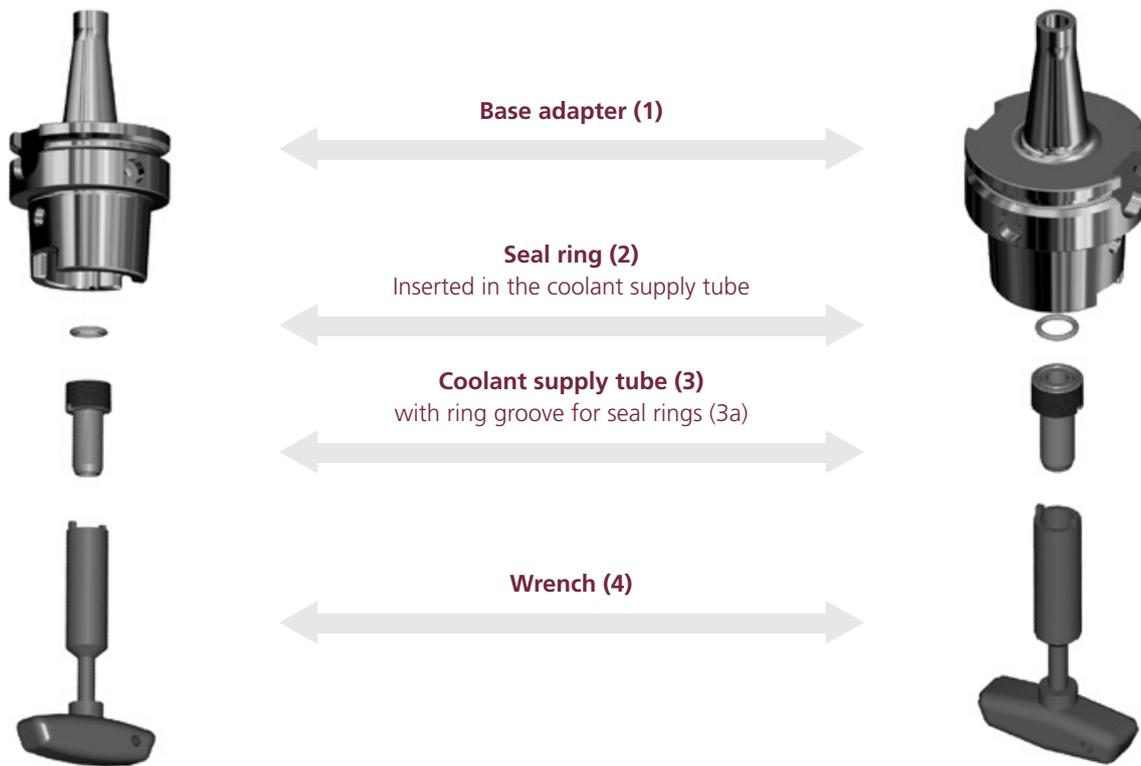

Step 1

Normally, the seal ring is already mounted in the supply tube. If it comes loose, please insert the seal ring (2) at the top of the ring groove (3a) of the supply tube (3).

Step 2

Insert the tube (3) with the narrow side in the wrench (4).

Step 3

Now, screw the tube into the adapter from below. Mount the adapter from the bottom to the top, ensuring that the seal ring does not slip or become crushed, in order to maintain its sealing function.

Assembly instructions

Pokolm DuoPlug®

To ensure optimal, secure fit of the DuoPlug® system, please observe the following instructions.

Assembly:

Preparations

Keep accessory tools (wrench, protective glasses, gloves) ready before warming up the work station.

Step 1

Remove the indexable inserts and their fastening screws.

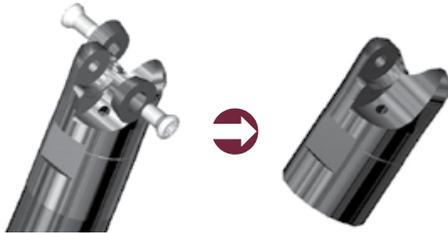

Step 2

Warning! The fit surfaces of the tool and arbor system must be absolutely free from dirt or grease. The DuoPlug® milling body must be screwed into the fit zone manually.

Do not use tools!



Step 3

Inductive heating with Pokolm induction shrinking unit for 6 to 15 seconds depending on the diameter. Then, start immediately with step 4.

Caution! Arbor and tool will be very hot afterwards!

Danger of burning!

Always wear gloves!



Step 4

The fitted bore of the tool will expand when heated. Only then can the tool be tightened to the stop surface of the adapter using an appropriate wrench. It should be possible to complete this step without excess force. If not, heat the DuoPlug®-mill body once again for a few seconds.



Step 5

Ensure that the tool and arbor are flat against one another. There may be no remaining gap.

Only complete these steps with moderate force.



Step 6

The shrink fit tool adapter unit may not be quenched, but should be cooled evenly using the cooling unit on the shrinking unit. Cooling the tool will cause the DuoPlug® milling body to draw back together. A frictional and positive-locking connection will be formed.



Step 7

Now, fit the tool with the desired indexable inserts. After measuring, you can start machining.



Disassembly:

Preparations

Keep accessory tools (wrench, protective glasses, gloves) ready before warming up the work station.

Always wear safety glasses during disassembly, since there is a risk of spray when coolant and lubricant residues are heated up.

Step 1

First, remove the indexable inserts and their fastening screws again.

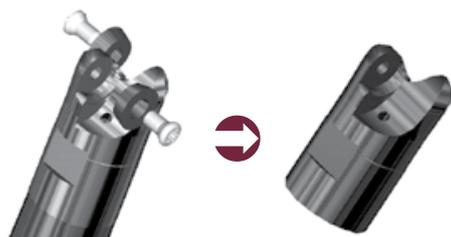

Step 2

Inductive heating with Pokolm induction shrinking unit for 6 to 15 seconds depending on the diameter.

Caution! Arbor and tool will be very hot afterwards!

Danger of burning!

Always wear gloves!



Of course, we are also happy to assist you with further questions on the DuoPlug® system.

Step 3

Inductive heating will cause the fitted bore of the tool to expand. **Only then** can the milling body be unscrewed from the adapter with an appropriate screw. It should be possible to complete this step without excess **force**. If not, heat the **DuoPlug®**-mill body once again for a few seconds.



Step 4

The unshrunk components may not be quenched. Instead, cool them down slowly using the cooling device on the shrinking unit, or use the storage station.

Caution! Arbor and tool will still be very hot!

Danger of burning!

Always wear gloves!



Recommendation

For shrink gripping, we recommend our convenient TS11000WK induction shrinking station, with a variety of innovative properties. Optimally designed to work with POKOLM products, the shrinking and liquid-supported cooling process is carried out semi-automatically in one position on the device. The operating concept is very user-friendly.

For further information, please request the brochure from Pokolm shrink grip technology. It is also available in the download area of our website, or simply scan the QR code:



Assembly instructions

Seal ring for CNC precision drill chuck

Two seal rings for different drill diameters are generally included in the scope of delivery of all Pokolm CNC precision drill chucks. Please observe the instructions when exchanging the seal rings or replacing them with a corresponding spare part.

Disassembly:

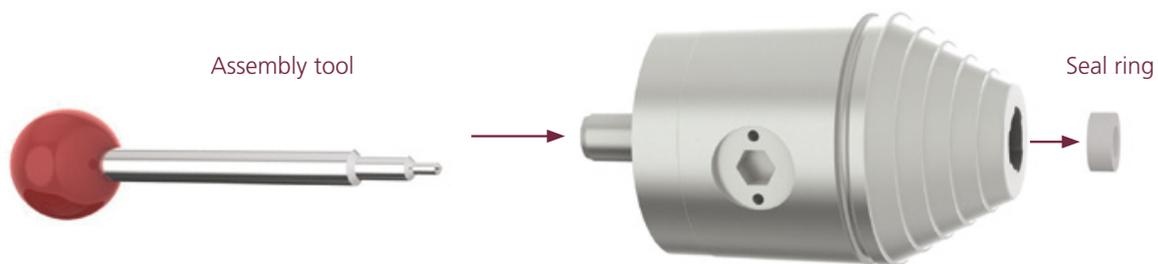

Step 1

Open the clamping jaws of the drill chuck with an Allen key. Dismantle the drill chuck on the machine side until the spindle can be freely accessed.

Step 2

Insert the assembly tool in the middle of the drill chuck on the side of the spindle until it meets resistance from the seal ring. By applying light pressure the seal ring can now be removed by pushing it forward and out through the clamping jaws.

Assembly:

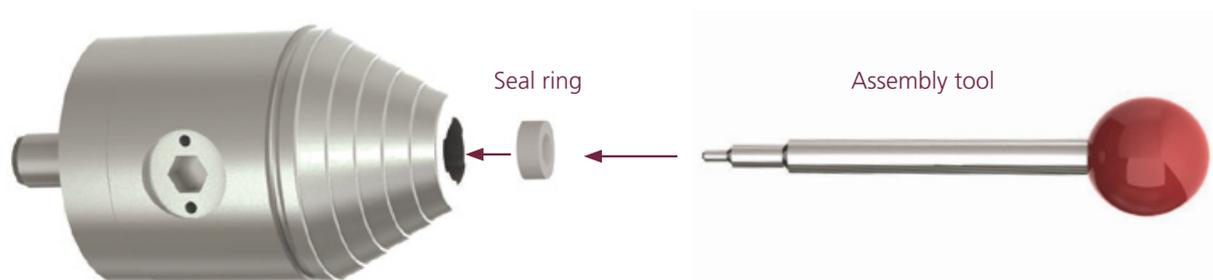

Step 1

Place the new seal ring with the hollow side facing the tool onto the assembly tool and insert from the front through the clamping jaw up to the seat of the seal ring. The seal ring is held in place with an O-ring.

Assembly instructions

Centering arbor and flat contact surface

In order to ensure a trouble-free insertion into the machine during centering and screwing-on the flat contact surface make sure that the centering arbor and the flat contact surface are not screwed together tightly. The fastening screw that is provided is constructed in such a way that it prevents the centering arbor and the flat contact surface from becoming tightly screwed together. Please observe the following instructions:

Assembly of the centering arbor:

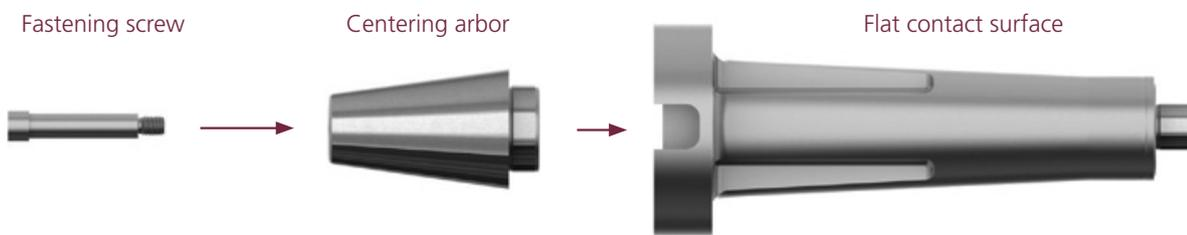

Step 1

Insert the centering arbor into the corresponding fitting of the flat contact surface.

Step 2

Insert the fastening screw that is provided into the centering arbor and screw into the threading of the flat contact surface with an Allen key (10 mm) and then tighten by hand. Now the centering arbor and the flat contact surface are connected to each other.

Assembling the retention knob:

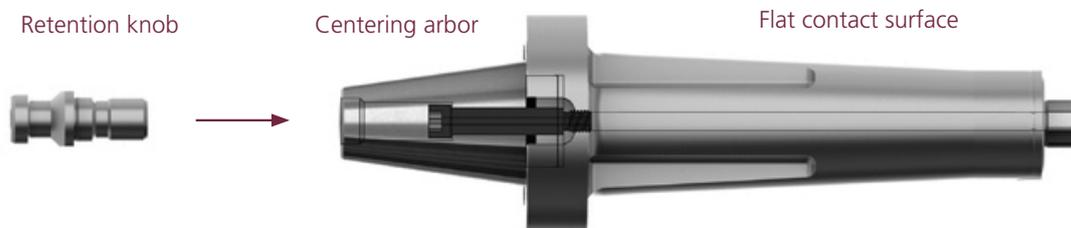

Step 1

Screw the retention knob into the inside thread of the centering arbor and tighten by hand. The flat contact surface can now be inserted and screwed to the machine.

PRODUCT VARIETY WITH THE HIGHEST PRECISION



The Pokolm toolbox
for every case

Shell-type extension and threaded shell-type adapter

Need to machine a particularly deep component? The required adapter length is non-standard? Producing a custom adapter is too complex? Short on time?

Special machining situations require special solutions.

Shell-type extensions and threaded shell-type adapters make it possible to easily achieve great processing depths, even in non-standard situations. An existing standard adapter is simply fit with the mounting bores indicated in the following diagram and table, then thread on, and you're done! This allows you to achieve extensions between 50 and 100 mm.

Of course, we are also happy to add the bores for you as a service.

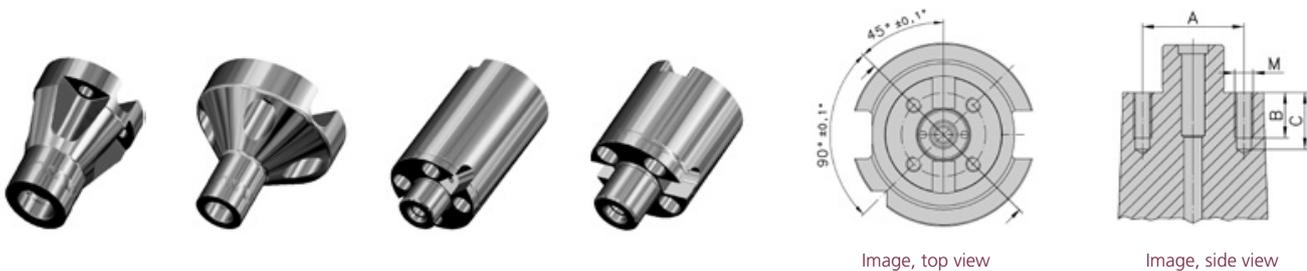

Order no.	Type	Pilot diameter	Adapter length	A	B	C	Screws*
60 22 Mxx 783	Threaded shell-type adapter	Diam. 22	60	Diam. 35	20	25	M 6 x 25
100 22 Mxx 783	Threaded shell-type adapter	Diam. 22	100	Diam. 35	20	25	M 6 x 25
60 27 Mxx 783	Threaded shell-type adapter	Diam. 27	60	Diam. 44.5	20	25	M 8 x 25
100 27 Mxx 783	Threaded shell-type adapter	Diam. 27	100	Diam. 44.5	20	25	M 8 x 25
50 22 782	Shell-type extension	Diam. 22	50	Diam. 35	20	25	M 6 x 55
100 22 782	Shell-type extension	Diam. 22	100	Diam. 35	20	25	M 6 x 55
50 27 782	Shell-type extension	Diam. 27	50	Diam. 44.5	20	25	M 8 x 55
100 27 782	Shell-type extension	Diam. 27	100	Diam. 44.5	20	25	M 8 x 55

*Four screws are required per adapter or extension. The screws are included in the scope of delivery.

Order no.	1	Page
100 16 754		121
100 16 754 Z		126
100 16 754 ZYL		122
100 16 A100 S		86
100 16 A100		85
100 16 A100 SR1		87
100 16 A100 SR1 W		88
100 16 A63 S		72
100 16 A63		69
100 16 A63		74
100 16 A63 SR1		76
100 16 A63 Z		78
100 16 A63 ZYL		70
100 20 710 S		132
100 20 714 S		144
100 20 750 S		110
100 20 750 SR1		114
100 20 A100 SR1		87
100 20 A100 SR1 W		88
100 20 A63 S		73
100 20 A63 SR1		76
100 22 710		134
100 22 714		146
100 22 750		116
100 22 754		126
100 22 782		42
100 22 A100		89
100 22 A63.01		78
100 22 M10 783		43
100 22 M12 783		43
100 22 M16 783		43
100 25 710 S		132
100 25 714 S		144
100 27 710		134
100 27 714		146
100 27 750		117
100 27 754		127
100 27 782		42
100 27 A100		89
100 27 A63		79
100 27 M10 783		43
100 27 M12 783		43
100 27 M16 783		43
100 27 M16 783-2		43
100 3 710		139
100 32 710		135
100 32 714		146
100 32 A100		90

Order no.	1	Page
100 40 710 Z		135
100 40 740		155
100 5 710		140
100 ER20 750		118
100 ER20 754		128
100 ER20 A63		83
100 MK2 AL A63		82
1003		161
1004		161
1005		161
104 12 604 S		29
110 08 604 S		29
110 10 604 S		29
112 03 604 S.01		29
112 04 604 S.01		29
112 06 604 S		29
112 08 604 S		29
115 03 604 S.01		29
115 04 604 S.01		29
115 06 604 S		29
12 40 780		38
12 40 781		39
12 60 780		38
12 60 781		39
120 07 603		26
120 08 601		33
120 08 606		31
120 10 601		33
120 10 606		31
120 12 606		32
120 12 MK4		35
120 16 MK5		36
120 MK3 AL A63		82
125 10 603		26
125 10 750		106
125 10 A63		68
125 12 601		33
125 12 603		26
125 12 750		106
125 12 A63		68
125 16 603		27
125 16 750		107
125 16 750 Z		116
125 16 A63		69
125 16 A63 Z		78
125 16 A63 ZYL		70
130 4 710		140
140 10 601		33

Order no.	1	Page
140 10 606		31
140 12 606		32
15 16 730 S		100
15 20 730 S		100
15 20 734 S		104
15 27 750		117
15 27 754		127
15 32 710 HDF		141
15 32 714 HDF		148
150 06 710 S		131
150 06 714 S		143
150 06 750 S		109
150 06 A100 S		86
150 06 A63 S		71
150 06 MK3 S		37
150 08 601		33
150 08 710 S		131
150 08 714 S		143
150 08 A100 S		86
150 08 A63 S		71
150 08 MK3 S		37
150 10 603		26
150 10 710 S		131
150 10 710		130
150 10 714 S		143
150 10 750		106
150 10 A100 S		86
150 10 A100		84
150 10 A63 S		72
150 10 A63		68
150 10 MK4 S		37
150 12 601		33
150 12 603		26
150 12 710 S		131
150 12 710		130
150 12 714 S		143
150 12 714		142
150 12 750		106
150 12 A100 S		86
150 12 A100		84
150 12 A63 S		72
150 12 A63		68
150 12 MK4 S		37
150 16 601/32		34
150 16 603		27
150 16 606/32		32

Item number index

Order no.	1	Page	Order no.	2	Page	Order no.	2	Page
150 16 710 S		132	20 06 600/10 G		40	200 22 750		116
150 16 710		130	20 06 600/10		41	200 22 754		126
150 16 710 Z		134	20 06 600/12 G		40	200 22 A100		89
150 16 714		144	20 06 600/12		41	200 22 A63		78
150 16 714		142	20 06 606/10 ZYL		31	200 27 710		134
150 16 714 Z		146	20 06 606/12 ZYL		31	200 27 714		146
150 16 750		107	20 07 603		26	200 27 740		154
150 16 750 Z		116	20 08 MK2		35	200 27 A100		89
150 16 754		121	20 10 MK2		35	200 27 A63		79
150 16 754 Z		126	20 16 600 G		40	200 3 710		139
150 16 A100 S		86	20 16 600		41	200 32 710		135
150 16 A100		85	20 501		161	200 32 714		146
150 16 A63 S		72	200 06 710 S		131	200 32 740		154
150 16 A63		69	200 06 714 S		143	200 40 740		155
150 16 A63 Z		78	200 06 A63 S		71	200 5 710		140
150 16 MK4 S		37	200 08 710 S		131	25 08 730		98
150 16 MK5		36	200 08 714 S		143	25 08 734		102
150 20 710 S		132	200 08 A63 S		71	25 08 750		106
150 22 710		134	200 08 MK5 S		37	25 08 754		121
150 22 714		146	200 10 710 S		131	25 08 A63		68
150 22 750		116	200 10 714 S		143	25 08 E40		56
150 22 754		126	200 10 A63 S		72	25 08 E50		61
150 22 A100		89	200 10 MK5 S		37	25 10 603		26
150 22 A63		78	200 12 710 S		131	25 10 730		98
150 27 710		134	200 12 710		130	25 10 734		102
150 27 714		146	200 12 714 S		143	25 10 750		106
150 27 754		127	200 12 714		142	25 10 754		121
150 27 A100		89	200 12 A100		84	25 10 A63		68
150 27 A63		79	200 12 A63 S		72	25 10 E40		56
150 3 710		139	200 12 MK5 S		37	25 10 E50		61
150 32 710		135	200 16 601/32		34	25 12 603		26
150 32 714		146	200 16 603		27	25 12 730		98
150 32 740		154	200 16 606/32		32	25 12 734		102
150 32 A100		90	200 16 710 S		132	25 12 750		106
150 40 740		155	200 16 710		130	25 12 754		121
150 5 710		140	200 16 710 Z		134	25 12 A63		68
16 40 780		38	200 16 714 S		144	25 12 E50		61
16 40 781		39	200 16 714		142	25 16 603		27
16 501 161			200 16 750		107	25 16 730		98
16 60 780		38	200 16 750 Z		116	25 16 734		102
16 60 781		39	200 16 A100		85	25 16 750		107
160 12 606		32	200 16 A63		69	25 16 750 Z		116
175 12 601		33	200 16 A63 Z		78	25 16 754		121
175 12 603		26	200 16 MK5 S		37	25 16 754 Z		126
175 16 603		27	200 22 710		134	25 16 A63		69
175 16 A63		69	200 22 714		146	25 16 A63 Z		78
180 16 MK5		36	200 22 740		154	25 16 E50		61
180 4 710		140						

Order no.	2	Page
25 20 600 G		40
25 20 600		41
25 22 750.01		116
25 22 754.01		126
25 22 A63.01		78
25 27 A63		79
250 12 710		130
250 12 714		142
250 12 A100		84
250 16 601/32		34
250 16 606/32		32
250 16 710		130
250 16 710 Z		134
250 16 714		142
250 16 750		107
250 16 A100		85
250 16 A63		69
250 22 710		134
250 22 740		154
250 27 710		134
250 27 740		154
250 32 740		154

Order no.	3	Page
30 12 MK3		35
30 25 600 G		40
30 25 600		41
300 12 710		130
300 12 714		142
300 12 A100		84
300 16 601/32		34
300 16 606/32		32
300 16 710		130
300 16 714		142
300 16 A100		85
300 22 740		154
300 27 740		154
300 32 740		154
35 06 10 SG		28
35 16 MK4		36
350 22 740		154
350 27 740		154
350 32 740		154
360 16 714		142

Order no.	4	Page
40 03 E25 S.01		52
40 03 E32 S.01		54
40 03 E40 S.01		57
40 03 EC 40 S.01		60
40 04 E25 S.01		52
40 04 E32 S.01		54
40 04 E40 S.01		57
40 04 EC 40 S.01		60
40 06 10 784 S		30
40 06 12 784 S		30
40 06 16 784 S		30
40 06 600/10 G		40
40 06 600/10		41
40 06 600/12 G		40
40 06 600/12		41
40 06 606/10 ZYL		31
40 06 606/12 ZYL		31
40 06 E25 S S52		52
40 06 E32 S		54
40 06 E40 S		57
40 06 EC 40 S		60
40 07 603		26
40 08 10 784 S		30
40 08 12 784 S		30
40 08 16 784 S		30
40 08 601		33
40 08 606		31
40 08 E25 S S52		52
40 08 E32 S		54
40 08 E40 S		57
40 08 EC 40 S		60
40 08 MK2		35
40 10 E25 S S52		52
40 10 E32 S		54
40 10 E40 S		57
40 10 EC 40 S		60
40 10 MK2		35
40 12 E40 S		57
40 12 EC 40 S		60
40 16 600 G		40
40 16 600		41
40 16 E40 S		57
40 16 EC 40 S		60
40 2 710		139
40 740 A100		156
40 ER16 E25		53

Order no.	4	Page
40 ER20 E32		55
400 22 740		154
400 27 740		154
400 32 740		154
43 06 12 SG		28
45 06 12 SG		28
45 08 12 SG		28
45 12 MK3		35
45 20 600 G		40
45 20 60		41

Order no.	5	Page
50 03 730 S.01		99
50 03 734 S.01		103
50 03 750 S.01		109
50 03 754 S.01		123
50 03 A63 S.01		71
50 03 E50 S.01		62
50 04 730 S.01		99
50 04 734 S.01		103
50 04 750 S.01		109
50 04 750 SR1		113
50 04 754 S.01		123
50 04 A63 S.01		71
50 04 A63 SR1		75
50 04 E50 S.01		62
50 04 E50 SR1		66
50 06 16 SG		28
50 06 710 S		131
50 06 714 S		143
50 06 730 S		99
50 06 734 S		103
50 06 750 S		109
50 06 750 SB		111
50 06 750 SR1		113
50 06 754 S		123
50 06 A63 S		71

Item number index

Order no.	5	Page	Order no.	5	Page	Order no.	5	Page
50 06 A63 SB		74	50 10 A63 SB		74	50 16 750 ZYL		108
50 06 A63 SR1		75	50 10 A63		68	50 16 754 S		123
50 06 E50 S		62	50 10 A63 SR1		75	50 16 754		121
50 06 E50 SR1		66	50 10 A63 SR1 W		77	50 16 754 Z		126
50 06 MK3 S		37	50 10 A63 ZYL		70	50 16 754 ZYL		122
50 08 16 SG		28	50 10 E40		56	50 16 A100		85
50 08 710 S		131	50 10 E50 S		62	50 16 A63 S		72
50 08 714 S		143	50 10 E50		61	50 16 A63		69
50 08 730 S		99	50 10 E50 SR1		67	50 16 A63		74
50 08 734 S S101		103	50 10 MK3 S		37	50 16 A63 Z		78
50 08 750 S		109	50 12 601		33	50 16 A63 ZYL		70
50 08 750 SB		111	50 12 601		33	50 16 E50 S		63
50 08 750		106	50 12 603		26	50 16 E50		61
50 08 750 SR1		113	50 12 710 S		131	50 16 MK4		36
50 08 750 ZYL		108	50 12 710		130	50 20 710 S		132
50 08 754 S		123	50 12 714 S		143	50 20 714 S		144
50 08 754		121	50 12 714		142	50 20 750 S		110
50 08 754 ZYL		122	50 12 730 S		99	50 20 754 S		123
50 08 A100		84	50 12 734 S S101		103	50 22 710		134
50 08 A63 S		71	50 12 750 S		110	50 22 710.01		134
50 08 A63 SB		74	50 12 750 SB		111	50 22 714.01		146
50 08 A63		68	50 12 750		106	50 22 750.01		116
50 08 A63 SR1		75	50 12 750 ZYL		108	50 22 754.01		126
50 08 A63 ZYL		70	50 12 754 S		123	50 22 782		42
50 08 E40		56	50 12 754		121	50 22 A100		89
50 08 E50 S		62	50 12 754 ZYL		122	50 22 A63.01		78
50 08 E50		61	50 12 A100		84	50 25 600 G		40
50 08 E50 SR1		66	50 12 A63 S		72	50 25 600		41
50 08 MK3 S		37	50 12 A63		68	50 27 710		134
50 10 16 SG		28	50 12 A63		74	50 27 714		146
50 10 603		26	50 12 A63 ZYL		70	50 27 750		117
50 10 710 S		131	50 12 E50 S		63	50 27 754		127
50 10 710		130	50 12 E50		61	50 27 782		42
50 10 714 S		143	50 12 E50 SR1		67	50 27 A100		89
50 10 730 S		99	50 12 MK3 S		37	50 27 A63		79
50 10 734 S S101		103	50 16 603		27	50 3 710		139
50 10 750 S		109	50 16 710 S		132	50 32 600 G		40
50 10 750 SB		111	50 16 710		130	50 32 600		41
50 10 750		106	50 16 710 Z		134	50 32 710		135
50 10 750 SR1		113	50 16 714 S		144	50 32 714		146
50 10 750 SR1 W		115	50 16 714		142	50 32 A100		90
50 10 750 ZYL		108	50 16 714 Z		146	50 40 710 Z		135
50 10 754 S		123	50 16 730 S		99	50 40 714 Z		147
50 10 754		121	50 16 734 S S101		103	50 40 A100		90
50 10 754 ZYL		122	50 16 750 S		110	50 60 710 Z		133
50 10 A100		84	50 16 750		107	50 60 714 Z		147
50 10 A63 S		72	50 16 750 Z		116	50 742		156

Order no.	5	Page
50 743 156		
50 ER20 730		101
50 ER20 734		105
50 ER20 750		118
50 ER20 754		128
50 ER20 A63		83
50 ER20 E40		59
50 ER20 E50		65

Order no.	6	Page
-----------	---	------

60 06 606/10 ZYL		31
60 06 606/12 ZYL		31
60 07 603/12		26
60 08 601		33
60 08 606		31
60 08 MK2		35
60 10 10 784 S		30
60 10 12 784 S		30
60 10 16 784 S		30
60 10 601		33
60 10 606		31
60 10 MK2		35
60 12 12 784 S		30
60 12 16 784 S		30
60 12 750 SR1		114
60 12 750 SR1 W		115
60 12 A63 SR1		76
60 12 A63 SR1 W		77
60 12 MK3		35
60 16 750 SR1		114
60 16 750 SR1 W		115
60 16 A100 S		86
60 16 A63 SR1		76
60 16 A63 SR1 W		77
60 20 750 SR1		114
60 20 750 SR1 W		115
60 20 A100 S		86
60 20 A63 S		73
60 20 A63 SR1		76
60 20 A63 SR1 W		77
60 20 E50 S		63
60 22 M10 783		43
60 22 M12 783		43
60 22 M16 783		43
60 25 710 S		132

Order no.	6	Page
60 25 714 S		144
60 25 750 S		110
60 25 754 S		124
60 25 A100 S		86
60 25 A63 S		73
60 27 M10 783		43
60 27 M12 783		43
60 27 M16 783		43
60 32 710 S		132
60 32 714 S		144
60 32 A63 S		73
65 16 MK4		36

Order no.	7	Page
-----------	---	------

70 03 E40 S.01		57
70 03 EC 40 S.01		60
70 04 E40 S.01		57
70 04 EC 40 S.01		60
70 06 E40 S		57
70 06 EC 40 S		60
70 08 E40 S		57
70 08 EC 40 S		60
70 10 E40 S		57
70 10 EC 40 S		60
70 12 E40 S		57
70 12 EC 40 S		60
70 32 A100 S		86
75 04 750 S.01		109
75 04 750 SR1		113
75 04 A63 S.01		71
75 04 A63 SR1		75
75 04 E50 SR1		66
75 06 750 S		109
75 06 A63 S		71
75 06 A63 SR1		75
75 06 E50 SR1		66
75 08 750 S		109
75 08 750		106
75 08 754		121
75 08 A63 S		71
75 08 A63		68
75 08 A63 SR1		75
75 08 E40		56
75 08 E50 SR1		66
75 10 603		26

Order no.	7	Page
75 10 710		130
75 10 750 S		109
75 10 750		106
75 10 750 ZYL		108
75 10 754		121
75 10 754 ZYL		122
75 10 A100		84
75 10 A63 S		72
75 10 A63		68
75 10 A63 SR1		75
75 10 A63 ZYL		70
75 10 E40		56
75 10 E50 SR1		67
75 12 601		33
75 12 603		26
75 12 750 S		110
75 12 750		106
75 12 750 ZYL		108
75 12 754		121
75 12 754 ZYL		122
75 12 A63 S		72
75 12 A63		68
75 12 A63 SR1		76
75 12 A63 ZYL		70
75 12 E50 SR1		67
75 12 MK3		35
75 16 603		27
75 16 750 S		110
75 16 750		107
75 16 750 Z		116
75 16 750 ZYL		108
75 16 754		121
75 16 754 Z		126
75 16 754 ZYL		122
75 16 A63 S		72
75 16 A63		69
75 16 A63 Z		78
75 16 A63 ZYL		70
75 20 750 S		110
75 22 750		116
75 22 754		126
75 22 A100		89
75 22 A63.01		78
75 27 750		117
75 27 754		127
75 27 A100		89
75 27 A63		79

Item number index

Order no.	8	Page
-----------	---	------

80 06 606/10 ZYL		31
80 06 606/12 ZYL		31
80 07 603/12		26
80 08 601		33
80 08 606		31
80 08 MK3		35
80 10 601		33
80 10 606		31
80 10 MK3		35
80 12 606		32
80 16 MK4		36
80 4 710		140

Order no.	9	Page
-----------	---	------

90 2 710		139
95 12 MK3		35
95 16 MK4		36

Order no.	A-Z	Page
-----------	-----	------

A200 16 710 VD		136
A200 16 750 VD		118
A200 16 A63 VD		80
A200 22 710 VD		136
A200 22 750 VD		118
A200 22 A100 VD		91
A200 22 A63 VD		80
A200 27 710 VD		137
A200 27 A100 VD		92
A300 16 710 VD		136
A300 16 750 VD		118
A300 16 A100 VD		91
A300 16 A63 VD		80
A300 22 710 VD		136
A300 22 750 VD		118
A300 22 A100 VD		91
A300 22 A63 VD		80
A300 27 710 VD		137
A300 27 A100 VD		92
BF 0.3-8 750 IC		119
BF 0.3-8 E40 IC		58

Order no.	A-Z	Page
-----------	-----	------

BF 0.3-8 E50 IC		64
BF 0.3-8 M16 IC		46
BF 0.5-13 710 IC		138
BF 0.5-13 750 IC		119
BF 0.5-13 A100 IC		93
BF 0.5-13 E50 IC		64
BF 0.5-13 M16 IC		46
BF 2.5-16 710 IC		138
BF 2.5-16 750 IC		119
BF 2,5-16 A100 IC		93
BF 2.5-16 E50 IC		64
BF 2.5-16 M16 IC		46
BF08DS04		163
BF08DS08		163
BF08MW		163
BF13DS06		163
BF13DS13		163
BF13MW		163
BF16DS06		163
BF16DS16		163
DMS 3/8 8-60 NM		163
ER16 001		161
ER16 1-2		44
ER16 2-3		44
ER16 3-4		44
ER16 4-5		44
ER16 5-6		44
ER16 7-8		44
ER16 8-9		44
ER16 9-10		44
ER20 0.5-1		45
ER20 001		161
ER20 11-12		45
ER20 1-2		45
ER20 2-3		45
ER20 3-4		45
ER20 4-5		45
ER20 5-6		45
ER20 7-8		45
ER20 9-10		45
GWST-M5X8-914		160
GWST-M6X10-914		160
HEXA 4T		161
KBSK30-69872A		162
KBSK30-69872B		162
KBSK40-69872A		162
KBSK40-69872B		162

Order no.	A-Z	Page
-----------	-----	------

KBSK50-69872A		162
KBSK50-69872B		162
KMR-100A		162
KMR-25		162
KMR-32		162
KMR-40A		162
KMR-50A		162
KMR-63A		162
M10X10		160
M10X35		161
M10X40		160
M10X45 IC		160
M10X9 SR1 W		160
M10X90		160
M12X10		160
M12X10 SR1 W		160
M12X135		160
M12X185		160
M12X25		160
M12X35		161
M12X40		160
M12X90		160
M14X11 SR1 W		160
M14X12		160
M16X10 SR1 W		160
M16X26		161
M16X50 IC		160
M16X50		160
M16X60		160
M20X30		161
M20X50		160
M3X10		160
M3X10		161
M4X10		160
M5X12		160
M5X16		160
M6X16		160
M6X25		160
M6X55		160
M8X25		160
M8X30		161
M8X55		160
HEXA 6T		161
NUTEN10X8		161
NUTEN12X12/2		161
NUTEN12X8		161
NUTEN14X14		161

Item number index

Order no.	A-Z	Page	Order no.	A-Z	Page	Order no.	A-Z	Page
NUTEN16X16		161	SR1 A08 SW21		163	SR1 S16 SW32		162
NUTEN25X26		161	SR1 A10 SW22		163	SR1 S20 SW36		162
NUTEN8X8		161	SR1 A12 SW27		163	SR1 S20 SW36		163
SCHLUESSELHSK100		162	SR1 A16 SW32		163	SR1 ZSW 002		163
SCHLUESSELHSK25		162	SR1 A20 SW36		163	Z 00038		163
SCHLUESSELHSK32		162	SR1 S04 SW15		162	Z 00104		160
SCHLUESSELHSK40		162	SR1 S06 SW17		162	Z 00142		161
SCHLUESSELHSK50		162	SR1 S08 SW21		162	ZGHM2414		163
SCHLUESSELHSK63		162	SR1 S10 SW22		162	ZGHM2414L		163
SR1 A06 SW17		163	SR1 S12 SW27		162	ZGHM3316L		163

Quick finder

Fit dimensions for threaded shank end mills

Thread	M 5	M 6	M 8	M 10	M 12	M 16
Fit dimension diameter in mm	5.5	6.5	8.5	10.5	12.5	17.0
Tightening torque in Nm	7	10	15	30	50	100

Thread sizes of arbors for shell type milling cutters:

Pilot diameter in mm	16	22	27	32	40
Fastening screw	M 8	M 10	M 12	M 16	M 20

Notes

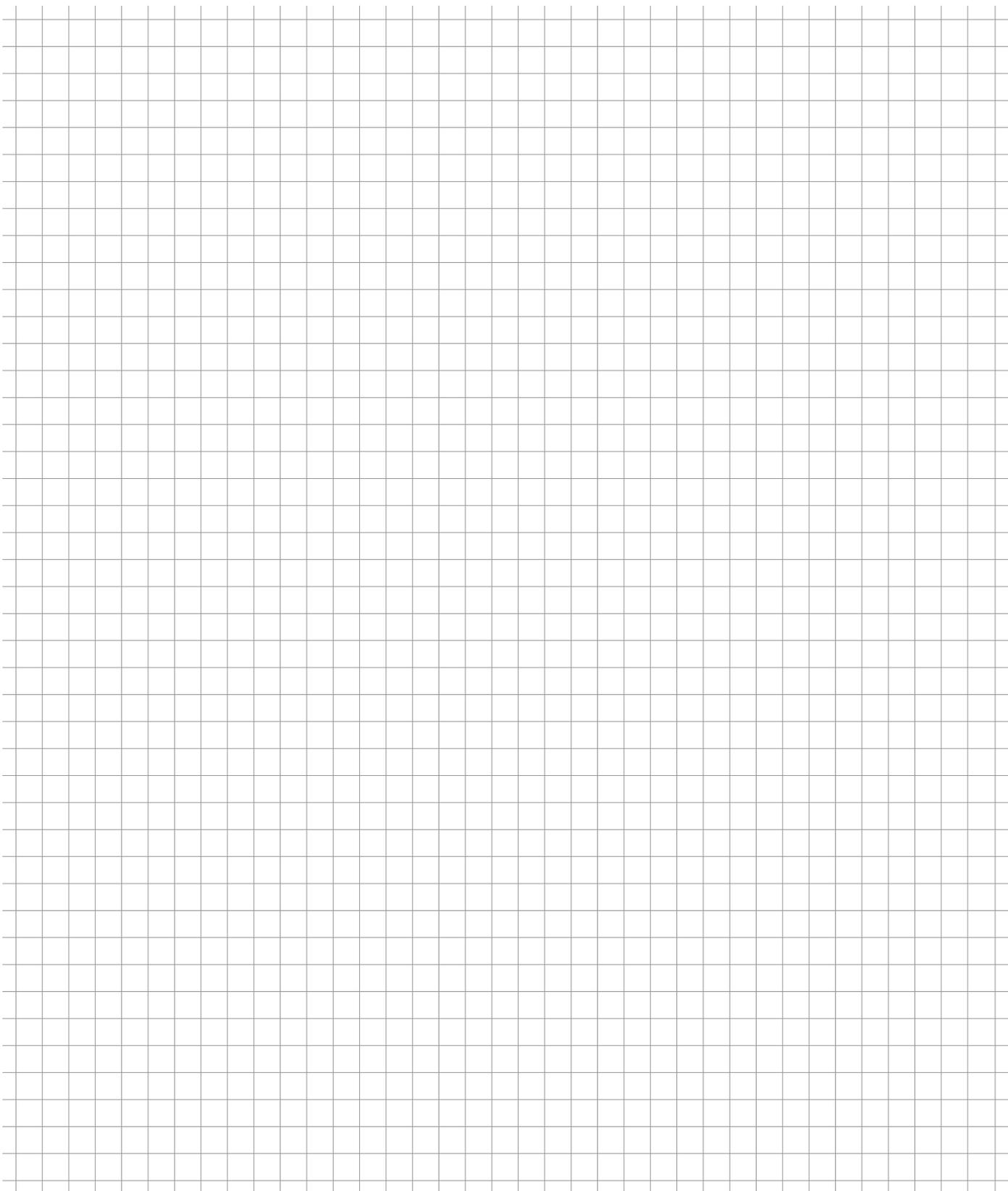
A large grid of graph paper for taking notes, consisting of 20 columns and 30 rows of small squares.

Notes

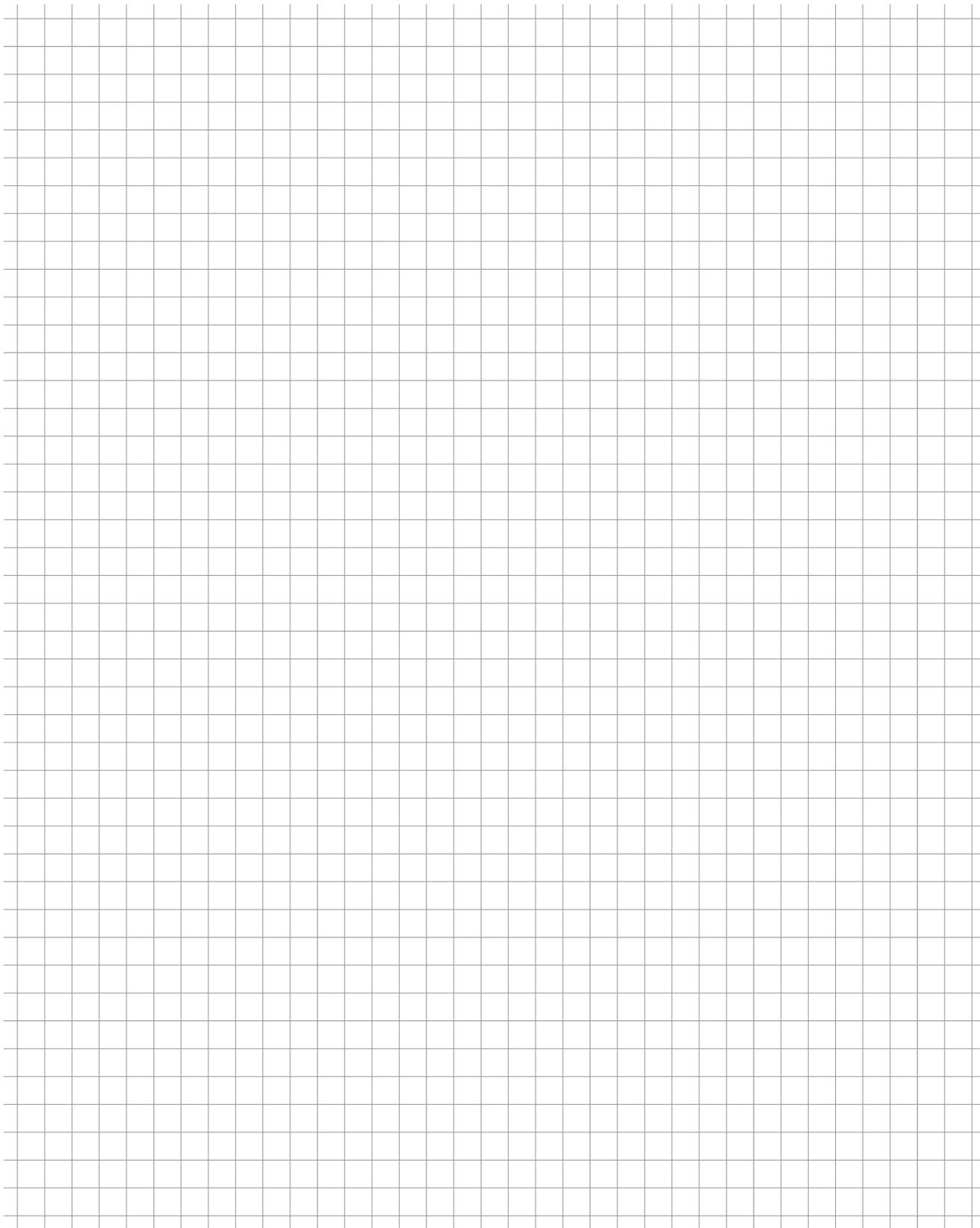

Notes

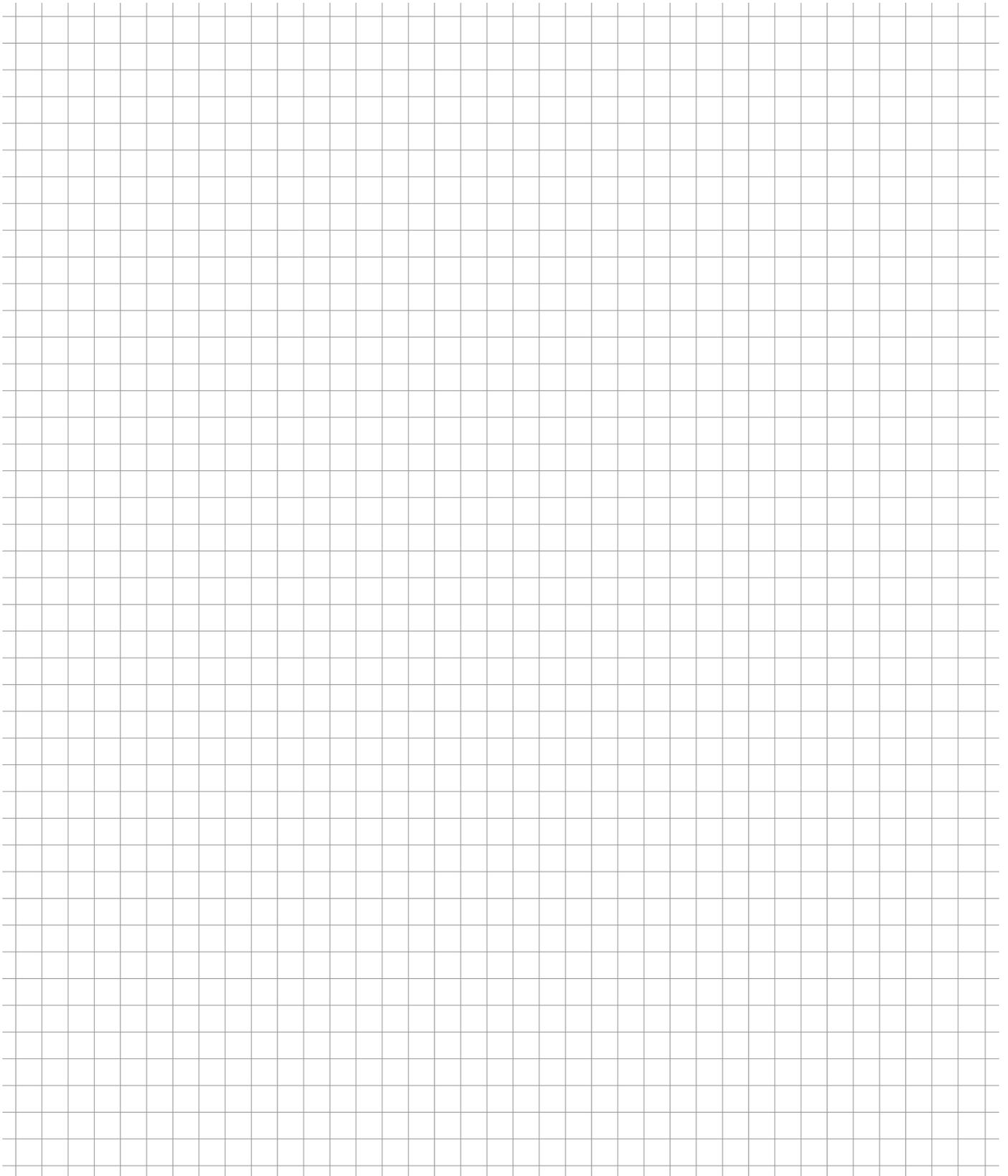
A large grid of graph paper for taking notes, consisting of 20 columns and 30 rows of small squares.

At a glance

Product features



ISO 7388-1



JIS B 6339 A



Max. speed 7000



Max. speed 6000



Zero length mount



Flange contact surface

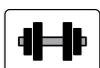

Heavy metal



Solid carbide

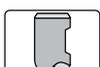

Weldon surface

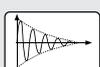

Vibration-dampened

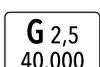

Balance quality G 2.5 40,000

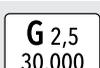

Balance quality G 2.5 30,000

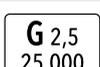

Balance quality G 2.5 25,000

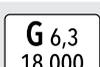

Balance quality G 6.3 18,000

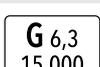

Balance quality G 6.3 15,000

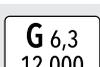

Balance quality G 6.3 12,000

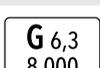

Balance quality G 6.3 8,000

Product features



Available from stock



CoolCap



DIN 1830



DIN 1835 A



DIN 1835 B



DIN 228 A



DIN 2079



DIN 6499-B



DIN 69871 AD



DIN 69893



DuoPlug®



Form A



Form BT



Form E



Form E+C



Suitable for HSC processing



Internal coolant supply

We are here for you!

If you have questions or need individual advice, our technical support team will be happy to assist you.



Service Hotline: +49 5247 9361-0

For further information, request our other catalogues:



Milling Cutter Bodies

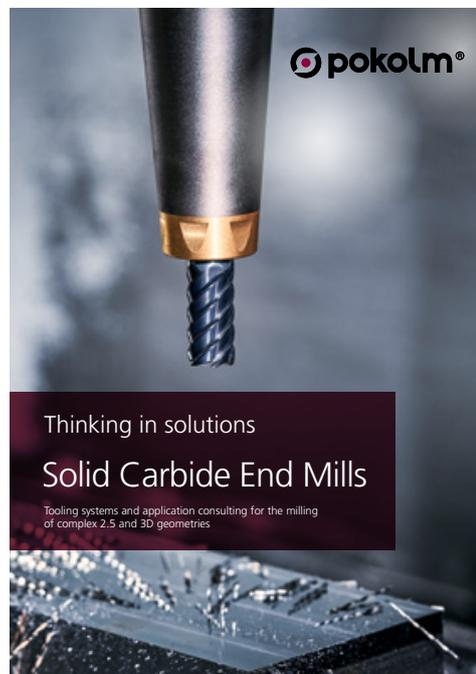

Solid Carbide End Mills



Pokolm Frästechnik GmbH & Co. KG

Adam-Opel-Straße 5
D-33428 Harsewinkel
Telephone: +49 5247 9361-0
Fax: +49 5247 9361-99

info@pokolm.de | www.pokolm.de/en



www.pokolm.de/en